

Precision meets Quality

Rhinology
Rhinologie

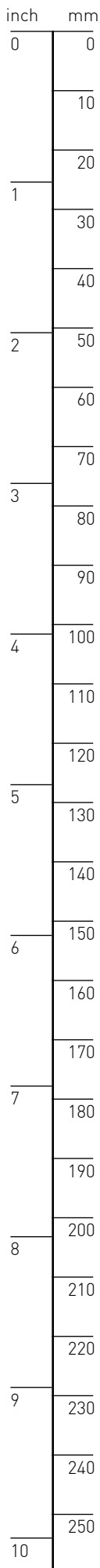

Edition 2024

The content of this catalogue is the literary property of FENTEX medical GmbH. The reproduction, translation or partial utilization of information is not permitted without prior written authorization from FENTEX medical.

All products shown in this catalogue carry a CE mark and are certified for distribution within the appropriate markets. Please note that some international markets have special certification requirements and that restrictions may apply. Information is available from FENTEX medical upon request.

Please refer to the current version of our general terms and conditions as well as the latest price list for further information on product availability and shipment terms.

We continuously strive to improve and update our products, to always meet or excel our customer's expectations and thus reserve the right to make alterations to our products without prior notice.



FENTEXmedical GmbH is certified according to EN ISO 13485 : 2016 + AC : 2016 and directive 93/42/EEC.

Katalogausgabe 2024

Der Inhalt des vorliegenden Kataloges ist das geistige Eigentum der Firma FENTEX medical GmbH. Reproduktionen, Übersetzungen oder auch die teilweise Verwertung von Informationen hieraus sind untersagt bzw. nur nach vorheriger schriftlicher Genehmigung durch die FENTEX GmbH erlaubt.

Bei Verstößen oder Missbrauch behalten wir uns rechtliche Schritte vor. Die Produkte tragen das CE Zeichen und sind damit für dessen Geltungsbereich zugelassen. Für einzelne geografische Märkte kann eine gesonderte Registrierung bzw. Zertifizierung notwendig sein. Informationen dazu werden auf Anfrage mitgeteilt.

Darüber hinaus gelten die Allgemeinen Geschäftsbedingungen der FENTEX Medical GmbH in der jeweils gültigen Fassung, sowie die jeweils aktuelle Preisliste.

Bitte beachten Sie, dass es in Einzelfällen zu leichten Maßabweichungen kommen kann, die aber die grundlegende Funktion der Produkte nicht beeinträchtigen. Modelländerungen vorbehalten.



FENTEXmedical GmbH ist zertifiziert nach EN ISO 13485 : 2016 + AC : 2016 und der Richtlinie 93/42/EWG.

Contact Details

Kontaktinformationen

FENTEXmedical GmbH
take-off GewerbePark 2
D-78579 Neuhausen ob Eck
Germany

Tel. +49 (0) 7467 - 949 62 0
Fax +49 (0) 7467 - 949 62 17

info@fentexmedical.com
www.fentexmedical.com

PRECISION MEETS QUALITY

FENTEXmedical GmbH is a medical company specializing in manufacturing and marketing of surgical instruments and endoscopy systems for ENT and Head & Neck surgeons.

Especially in this part of the human body with its anatomical and functional complexity and high aesthetic demands special skills are required. It is our mission not only to meet but to surpass these requirements with our products and services.

PRECISION MEETS QUALITY

FENTEXmedical GmbH ist ein Unternehmen, das sich auf die Entwicklung, Produktion und den Vertrieb chirurgischer Instrumente und Endoskopiesysteme für die Hals- Nasen und Ohrenheilkunde spezialisiert hat.

Gerade in diesem Bereich des menschlichen Körpers sind aufgrund der anatomischen und funktionalen Komplexität sowie der hohen ästhetischen Anforderungen besondere Qualitäten gefordert. Es ist unsere Mission, diese Qualitätsanforderungen mit unseren Produkten und Dienstleistungen nicht nur zu erfüllen sondern zu übertreffen.

Rhinology Rhinologie

Precision

We maintain a close cooperation with all of the medical specialists involved in head & neck surgery, including ENT-, Otolaryngologists and Plastic Surgeons. This cooperation allows us to precisely adapt the instrument and match it with the requirements of a particular operational technique. It also ensures that the latest developments are being consistently incorporated into our products. Together with our superior design and finishing we help to ensure your surgical achievements.

Präzision

Wir pflegen die enge Kooperation mit Spezialisten aller im Kopf- und Halsbereich tätigen chirurgischen Disziplinen. Dadurch können wir Ihnen für jede Indikation das passende Instrument bereitstellen und halten unser gesamtes Sortiment auf dem aktuellen Stand der medizinischen Entwicklung. Die Präzision in der Ausführung der Instrumente sichert Ihnen den Operationserfolg.

Customer Orientation

We market our products world wide through highly qualified specialist dealers thus achieving a maximum in local customer-service and -support. Our organisation is open to suggestions from clinical users and demand for custom made devices.

Kundenorientierung

Wir vertreiben unsere Produkte weltweit durch ein fachlich versiertes Händlernetz und erreichen dadurch ein Maximum in der Kundenbetreuung vor Ort. Darüber hinaus sind wir auch jederzeit ansprechbar im Hinblick auf die Sonderwünsche unserer Kunden.



040100FX **Nasal Speculum by Tieck-Halle**, for babies, 13 cm, blade length 17.5 mm
Nasenspekulum nach Tieck-Halle, für Kleinkinder, 13 cm, Blattlänge 17,5 mm

040100FX for babies / 13 cm, blade length 17.5 mm für Kleinkinder / 13 cm, Blattlänge 17,5 mm

040110FX for children / 14 cm, blade length 21 mm für Kinder / 14 cm, Blattlänge 21 mm

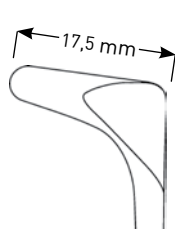

040100FX

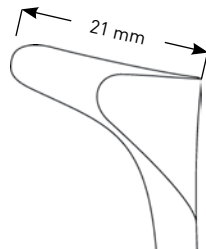

040110FX



041101FX **Nasal Speculum by Hartmann-Halle**, 15.5 cm, blade length 29 mm, size 1
Nasenspekulum nach Hartmann-Halle, 15,5 cm, Blattlänge 29 mm, Fig. 1

041101FX 15.5 cm, blade length 29 mm, size 1 15,5 cm, Blattlänge 29 mm, Fig. 1

041102FX 15.5 cm, blade length 33 mm, size 2 15,5 cm, Blattlänge 33 mm, Fig. 2

041103FX 15.5 cm, blade length 37 mm, size 3 15,5 cm, Blattlänge 37 mm, Fig. 3

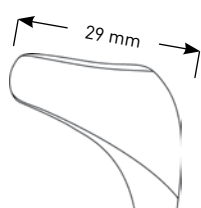

041101FX

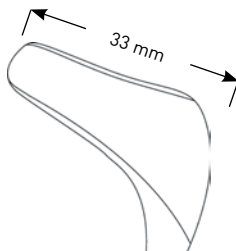

041102FX

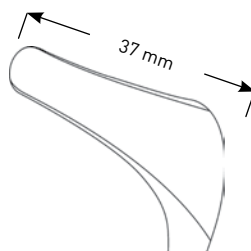

041103FX



041401FX **Nasal Speculum by Thudichum, small, 6.5 cm**
Nasenspekulum nach Thudichum, klein, 6,5 cm

041401FX	small / 6.5 cm	klein / 6,5 cm
041402FX	medium / 6.5 cm	mittel / 6,5 cm
041403FX	large / 6.5 cm	groß / 6,5 cm

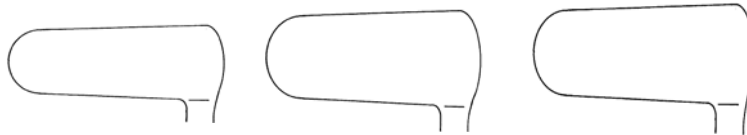

041401FX

041402FX

041403FX



041601FX **Nasal Speculum by Hartmann**, 15 cm, blade length 27 mm, size 1
Nasenspekulum nach Hartmann, 15 cm, Blattlänge 27 mm, Fig. 1

041601FX	15 cm, blade length 27 mm, size 1	15 cm, Blattlänge 27 mm, Fig. 1
041602FX	15 cm, blade length 30 mm, size 2	15 cm, Blattlänge 30 mm, Fig. 2
041603FX	15 cm, blade length 34 mm, size 3	15 cm, Blattlänge 34 mm, Fig. 3

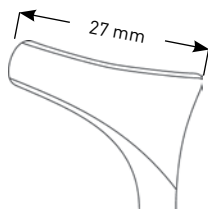

041601FX

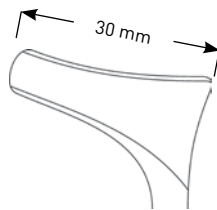

041602FX

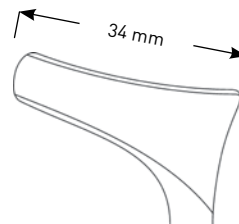

041603FX



041701FX **Nasal Speculum Model Vienna**, 14 cm, blade length 26 mm, size 1
Nasenspekulum Modell Wien, 14 cm, Blattlänge 26 mm, Fig. 1

041701FX	14 cm, blade length 26 mm, size 1	14 cm, Blattlänge 26 mm, Fig. 1
041702FX	14 cm, blade length 29.5 mm, size 2	14 cm, Blattlänge 29,5 mm, Fig. 2
041703FX	14 cm, blade length 33 mm, size 3	14 cm, Blattlänge 33 mm, Fig. 3

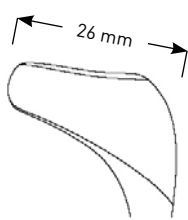

041701FX

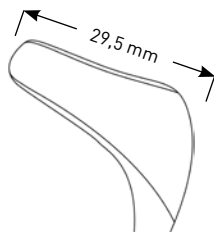

041702FX

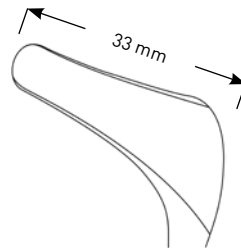

041703FX



041801FX **Nasal Speculum by Beckmann**, 15 cm, blade length 22 mm, Size 1
Nasenspekulum nach Beckmann, 15 cm, Blattlänge 22 mm, Fig. 1

041801FX 15 cm, blade length 22 mm, Size 1
15 cm, Blattlänge 22 mm, Fig. 1

041802FX 15 cm, blade length 25 mm, Size 2
15 cm, Blattlänge 25 mm, Fig. 2

041803FX 15 cm, blade length 29 mm, Size 3
15 cm, Blattlänge 29 mm, Fig. 3



043101FX **Nasal Speculum by Hartmann**, for adults, 13 cm, blade length 34 mm
Nasenspekulum nach Hartmann, für Erwachsene, 13 cm, Blattlänge 34 mm

043101FX for adults / 13 cm, blade length 34 mm für Erwachsene / 13 cm, Blattlänge 34 mm

043102FX for children / 13 cm, blade length 27 mm für Kinder / 13 cm, Blattlänge 27 mm

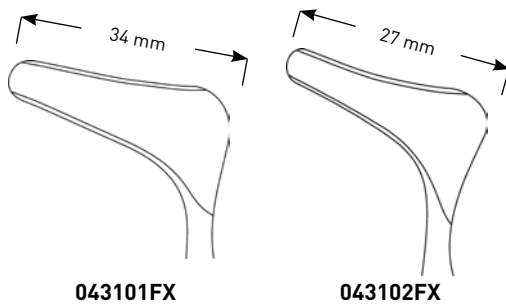



042001FX **Nasal Speculum by Killian**, with set screw, 14 cm, blade length 40 mm, size 1
Nasenspekulum nach Killian, mit Stellschraube, 14 cm, Blattlänge 40 mm, Fig. 1

042001FX	with set screw / 14 cm, blade length 40 mm, size 1	mit Stellschraube / 14 cm, Blattlänge 40 mm, Fig. 1
042002FX	with set screw / 14 cm, blade length 55 mm, size 2	mit Stellschraube / 14 cm, Blattlänge 55 mm, Fig. 2
042003FX	with set screw / 14 cm, blade length 75 mm, size 3	mit Stellschraube / 14 cm, Blattlänge 75 mm, Fig. 3
042004FX	with set screw / 14 cm, blade length 90 mm, size 4	mit Stellschraube / 14 cm, Blattlänge 90 mm, Fig. 4

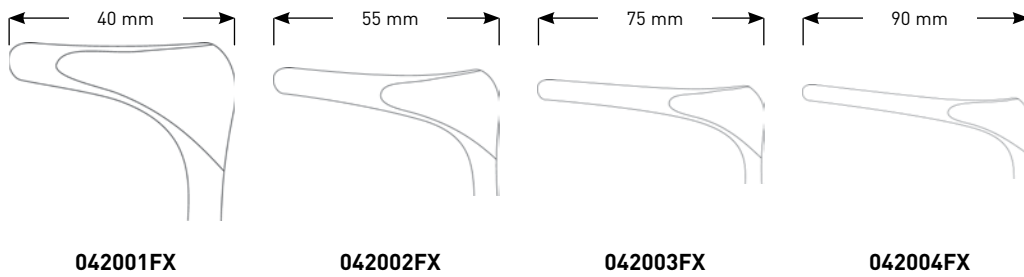



042101FX **Nasal Speculum by Killian**, 14 cm, blade length 40 mm, size 1
Nasenspekulum nach Killian, 14 cm, Blattlänge 40 mm, Fig. 1

042101FX	14 cm, blade length 40 mm, size 1	14 cm, Blattlänge 40 mm, Fig. 1
042102FX	14 cm, blade length 55 mm, size 2	14 cm, Blattlänge 55 mm, Fig. 2
042103FX	14 cm, blade length 75 mm, size 3	14 cm, Blattlänge 75 mm, Fig. 3
042104FX	14 cm, blade length 90 mm, size 4	14 cm, Blattlänge 90 mm, Fig. 4

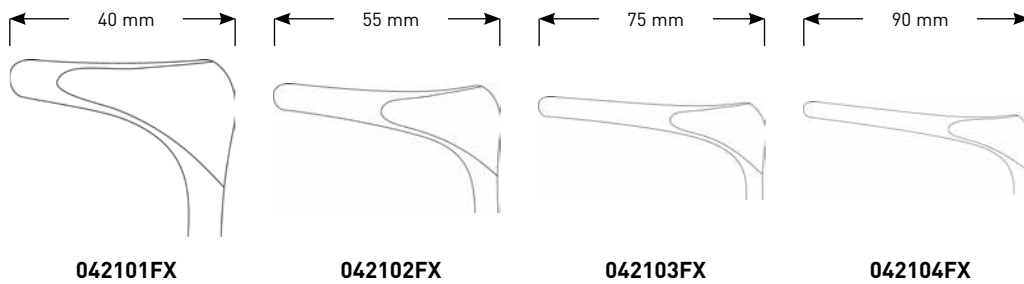



042240FX **Nasal Speculum by Killian-Struycken**, with set screw, 14 cm, blade length 40 mm, size 1
Nasenspekulum nach Killian-Struycken, mit Stellschraube, 14 cm, Blattlänge 40 mm, Fig. 1

042240FX	with set screw / 14 cm, blade length 40 mm, size 1	mit Stellschraube / 14 cm, Blattlänge 40 mm, Fig. 1
042255FX	with set screw / 14 cm, blade length 55 mm, size 2	mit Stellschraube / 14 cm, Blattlänge 55 mm, Fig. 2
042275FX	with set screw / 14 cm, blade length 75 mm, size 3	mit Stellschraube / 14 cm, Blattlänge 75 mm, Fig. 3
042290FX	with set screw / 14 cm, blade length 90 mm, size 4	mit Stellschraube / 14 cm, Blattlänge 90 mm, Fig. 4

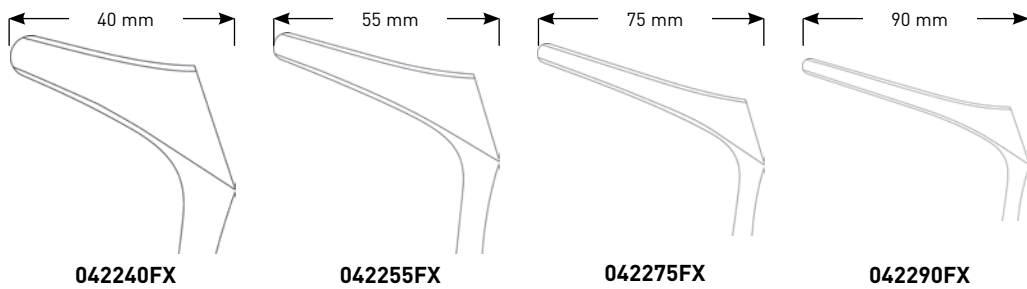



042340FX **Nasal Speculum by Killian-Struycken**, 14 cm, blade length 40 mm, size 1
Nasenspekulum nach Killian-Struycken, 14 cm, Blattlänge 40 mm, Fig. 1

042340FX	14 cm, blade length 40 mm, size 1	14 cm, Blattlänge 40 mm, Fig. 1
042355FX	14 cm, blade length 55 mm, size 2	14 cm, Blattlänge 55 mm, Fig. 2
042375FX	14 cm, blade length 75 mm, size 3	14 cm, Blattlänge 75 mm, Fig. 3
042390FX	14 cm, blade length 90 mm, size 4	14 cm, Blattlänge 90 mm, Fig. 4

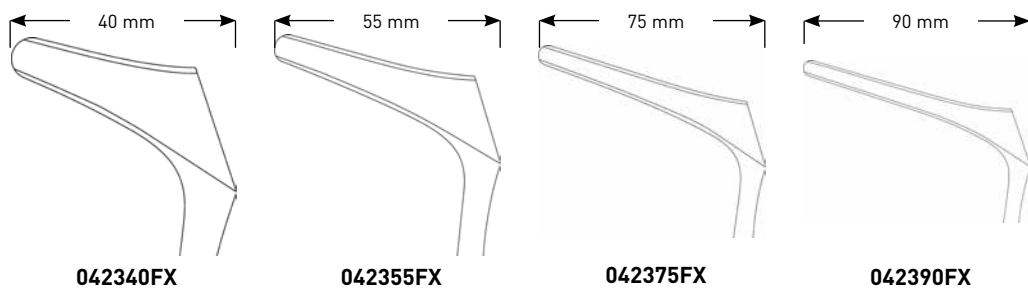



042755FX **Nasal Speculum by Killian**, with light carrier 042700FX, 14 cm, blade length 55 mm, size 2
Nasenspekulum nach Killian, mit Lichtträger 042700FX, 14 cm, Blattlänge 55 mm, Fig. 2

042740FX with light carrier 042700FX / 14 cm, blade length 40 mm, size 1
 mit Lichtträger 042700FX / 14 cm, Blattlänge 40 mm, Fig. 1

042755FX with light carrier 042700FX / 14 cm, blade length 55 mm, size 2
 mit Lichtträger 042700FX / 14 cm, Blattlänge 55 mm, Fig. 2

042775FX with light carrier 042700FX / 14 cm, blade length 75 mm, size 3
 mit Lichtträger 042700FX / 14 cm, Blattlänge 75 mm, Fig. 3

042790FX with light carrier 042700FX / 14 cm, blade length 90 mm, size 4
 mit Lichtträger 042700FX / 14 cm, Blattlänge 90 mm, Fig. 4

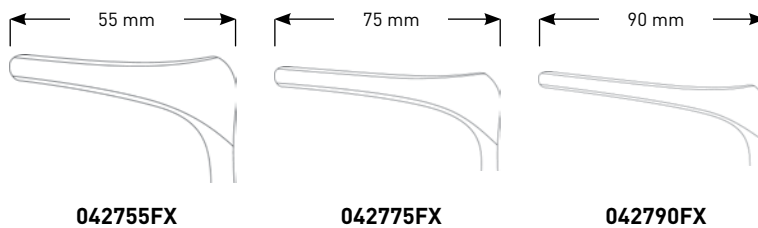

042755FX

042775FX

042790FX



042700FX **Light Carrier**, for 042740FX - 042790FX, Ø 3 mm
Lichtträger, für 042740FX - 042790FX, Ø 3 mm



300101FX **Nasal Speculum by Cottle**, with set screw, 13 cm, size 1, blade length 35 mm
Nasenspekulum nach Cottle, mit Stellschraube, 13 cm, Fig. 1, Blattlänge 35 mm

300101FX	with set screw / 13 cm, size 1, blade length 35 mm	mit Stellschraube / 13 cm, Fig. 1, Blattlänge 35 mm
300102FX	with set screw / 13 cm, size 2, blade length 50 mm	mit Stellschraube / 13 cm, Fig. 2, Blattlänge 50 mm
300103FX	with set screw / 13 cm, size 3, blade length 75 mm	mit Stellschraube / 13 cm, Fig. 3, Blattlänge 75 mm
300104FX	with set screw / 13 cm, size 4, blade length 90 mm	mit Stellschraube / 13 cm, Fig. 4, Blattlänge 90 mm

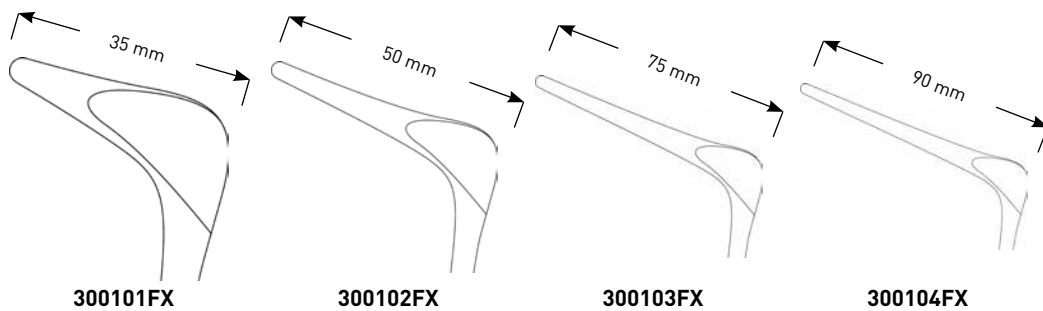



300201FX **Nasal Speculum by Cottle, 13 cm, size 1, blade length 35 mm**
Nasenspekulum nach Cottle, 13 cm, Fig. 1, Blattlänge 35 mm

300201FX	13 cm, size 1, blade length 35 mm	13 cm, Fig. 1, Blattlänge 35 mm
300202FX	13 cm, size 2, blade length 50 mm	13 cm, Fig. 2, Blattlänge 50 mm
300203FX	13 cm, size 3, blade length 75 mm	13 cm, Fig. 3, Blattlänge 75 mm
300204FX	13 cm, size 4, blade length 90 mm	13 cm, Fig. 4, Blattlänge 90 mm

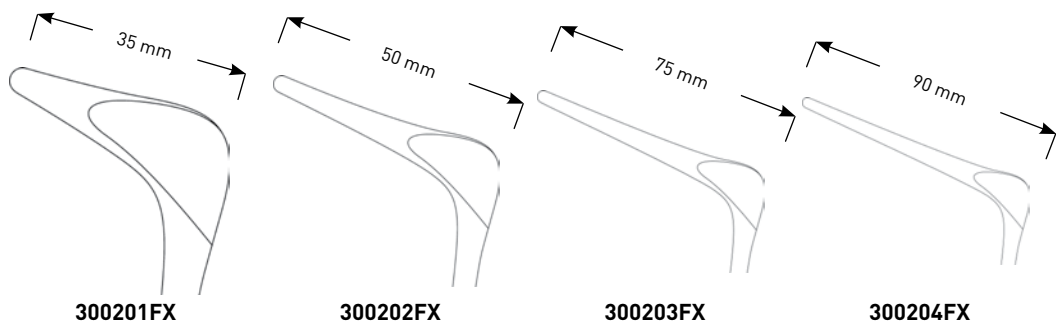

Rhinology
Rhinologie



300601FX **Nasal Speculum by Cottle**, black, with set screw, 13 cm, blade length 35 mm
Nasenspekulum nach Cottle, schwarz, mit Stellschraube, 13 cm, Blattlänge 35 mm

300601FX	black, with set screw / 13 cm, blade length 35 mm	schwarz, mit Stellschraube / 13 cm, Blattlänge 35 mm
300603FX	black, with set screw / 13 cm, blade length 50 mm	schwarz, mit Stellschraube / 13 cm, Blattlänge 50 mm
300604FX	black, with set screw / 13 cm, blade length 75 mm	schwarz, mit Stellschraube / 13 cm, Blattlänge 75 mm



300640FX **Nasal Speculum by Killian-Walter**, extra thin blades, with set screw, 14 cm, blade length 40 mm
Nasenspekulum nach Killian-Walter, sehr dünne Blätter, mit Stellschraube, 14 cm, Blattlänge 40 mm

300640FX	extra thin blades, with set screw / 14 cm, blade length 40 mm sehr dünne Blätter, mit Stellschraube / 14 cm, Blattlänge 40 mm
300655FX	extra thin blades, with set screw / 14 cm, blade length 55 mm sehr dünne Blätter, mit Stellschraube / 14 cm, Blattlänge 55 mm
300675FX	extra thin blades, with set screw / 14 cm, blade length 75 mm sehr dünne Blätter, mit Stellschraube / 14 cm, Blattlänge 75 mm
300690FX	extra thin blades, with set screw / 14 cm, blade length 90 mm sehr dünne Blätter, mit Stellschraube / 14 cm, Blattlänge 90 mm

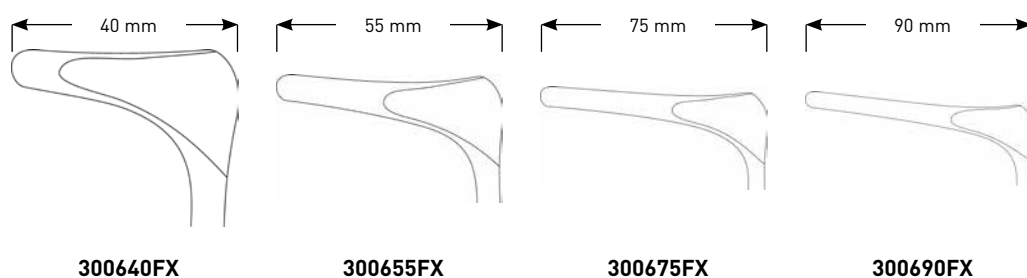



300740FX **Nasal Speculum by Killian**, tapered, with set screw, 14 cm, size 1, blade length 40 mm
Nasenspekulum nach Killian, spitz zulaufend, mit Stellschraube, 14 cm, Fig. 1, Blattlänge 40 mm

300740FX tapered, with set screw / 14 cm, size 1, blade length 40 mm
 spitz zulaufend, mit Stellschraube / 14 cm, Fig. 1, Blattlänge 40 mm

300755FX tapered, with set screw / 14 cm, size 2, blade length 55 mm
 spitz zulaufend, mit Stellschraube / 14 cm, Fig. 2, Blattlänge 55 mm

300775FX tapered, with set screw / 14 cm, size 3, blade length 75 mm
 spitz zulaufend, mit Stellschraube / 14 cm, Fig. 3, Blattlänge 75 mm

300790FX tapered, with set screw / 14 cm, size 4, blade length 90 mm
 spitz zulaufend, mit Stellschraube / 14 cm, Fig. 4, Blattlänge 90 mm

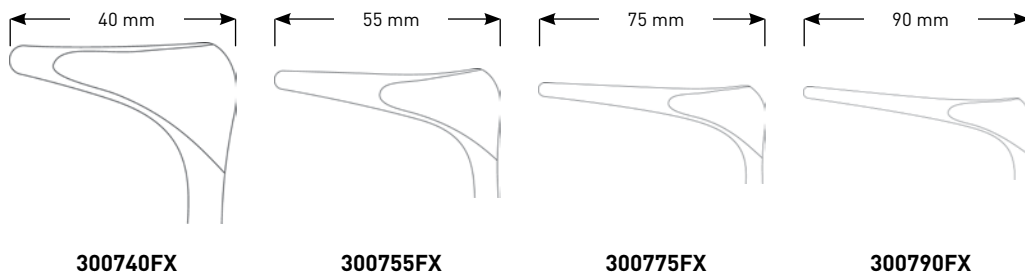



300840FX **Nasal Speculum by Killian**, tapered, 14 cm, size 1, blade length 40 mm
Nasenspekulum nach Killian, spitz zulaufend, 14 cm, Fig. 1, Blattlänge 40 mm

300840FX tapered / 14 cm, size 1, blade length 40 mm
spitz zulaufend / 14 cm, Fig. 1, Blattlänge 40 mm

300855FX tapered / 14 cm, size 2, blade length 55 mm
spitz zulaufend / 14 cm, Fig. 2, Blattlänge 55 mm

300875FX tapered / 14 cm, size 3, blade length 75 mm
spitz zulaufend / 14 cm, Fig. 3, Blattlänge 75 mm

300890FX tapered / 14 cm, size 4, blade length 90 mm
spitz zulaufend / 14 cm, Fig. 4, Blattlänge 90 mm

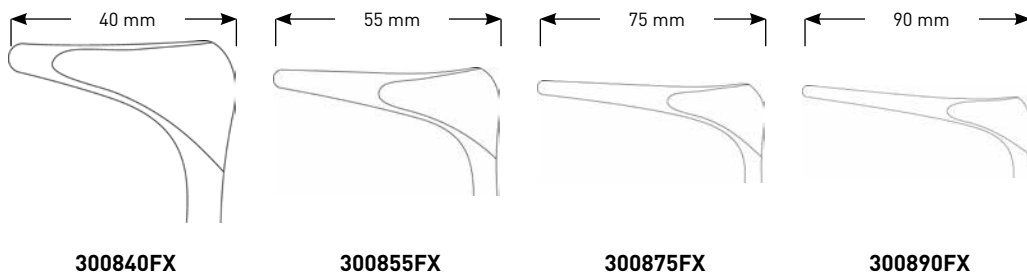



118900FX **Flexible Arm with Holding Rod**
Flexibler Arm mit Haltestange



118901FX **Clamp, for Flexible Arm 118900FX**
Spannkloben, für Flexiblen Arm 118900FX



118904FX **Adapter, for Flexible Arm 118900FX**
Adapter, für Flexiblen Arm 118900FX

Rhinology
Rhinologie



397400FX **Nasal Retractor by Aufricht**, for 118900FX
Nasenhaken nach Aufricht, für 118900FX



397500FX **Nasal Retractor by Aufricht**, for 118900FX, 2 teeth
Nasenhaken nach Aufricht, für 118900FX, zweizahnig



397701FX **Nasal Speculum by Killian**, for 118900FX, right blade shortened, 15 cm, blade length left 55 mm
Nasenspekulum nach Killian, für 118900FX, rechtes Blatt gekürzt, 15 cm, Blattlänge links 55 mm



397702FX **Nasal Speculum by Killian**, for 118900FX, left blade shortened, 15 cm, blade length right 55 mm
Nasenspekulum nach Killian, für 118900FX, linkes Blatt gekürzt, 15 cm, Blattlänge rechts 55 mm



397705FX **Nasal Speculum by Killian**, for 118900FX, right blade shortened, 15 cm, blade length left 75 mm
Nasenspekulum nach Killian, für 118900FX, rechtes Blatt gekürzt, 15 cm, Blattlänge links 75 mm



397706FX **Nasal Speculum by Killian**, for 118900FX, left blade shortened, 15 cm, blade length right 75 mm
Nasenspekulum nach Killian, für 118900FX, linkes Blatt gekürzt, 15 cm, Blattlänge rechts 75 mm



032113FX **Ear Dressing Forceps by Troeltsch**, serrated, 13 cm, WL 7.5 cm
Ohrpinzette nach Troeltsch, gerieft, 13 cm, NL 7,5 cm



032116FX **Ear Dressing Forceps by Troeltsch**, serrated, 16 cm
Ohrpinzette nach Troeltsch, gerieft, 16 cm



032118FX **Ear Dressing Forceps by Troeltsch**, serrated, 18 cm, WL 10 cm
Ohrpinzette nach Troeltsch, gerieft, 18 cm, NL 10 cm

Rhinology
Rhinologie



032416FX **Ear Dressing Forceps by Jansen**, bayonet-shaped, 16 cm
Ohrpinzette nach Jansen, bajonettförmig, 16 cm



032419FX **Ear Dressing Forceps by Gruenwald**, bayonet-shaped, 19 cm
Ohrpinzette nach Grünwald, bajonettförmig, 19 cm



045600FX **Choana Hook by Lange**, 22 cm
Choanenhaken nach Lange, 22 cm

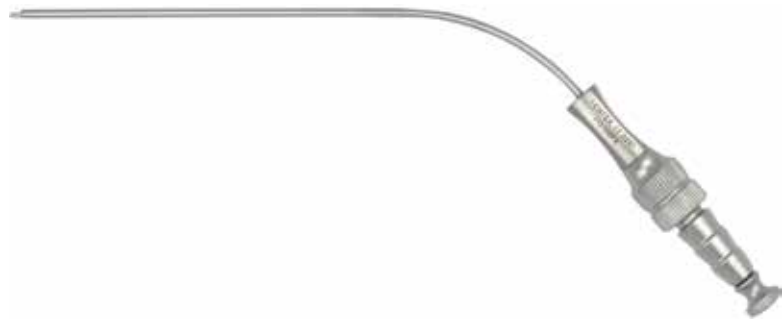

110106FX **Suction Tube by Frazier**, straight tip, with cut-off hole, WL 10 cm, 6 Fr.
Saugrohr nach Frazier, gerades Ende, mit Unterbrecherloch, NL 10 cm, 6 Charr.

110106FX	straight tip, with cut-off hole / WL 10 cm, 6 Fr.	gerades Ende, mit Unterbrecherloch / NL 10 cm, 6 Charr.
110107FX	straight tip, with cut-off hole / WL 10 cm, 7 Fr.	gerades Ende, mit Unterbrecherloch / NL 10 cm, 7 Charr.
110108FX	straight tip, with cut-off hole / WL 10 cm, 8 Fr.	gerades Ende, mit Unterbrecherloch / NL 10 cm, 8 Charr.
110110FX	straight tip, with cut-off hole / WL 10 cm, 10 Fr.	gerades Ende, mit Unterbrecherloch / NL 10 cm, 10 Charr.
110112FX	straight tip, with cut-off hole / WL 10 cm, 12 Fr.	gerades Ende, mit Unterbrecherloch / NL 10 cm, 12 Charr.
110115FX	straight tip, with cut-off hole / WL 10 cm, 15 Fr.	gerades Ende, mit Unterbrecherloch / NL 10 cm, 15 Charr.



250106FX **Suction Tube by Frazier**, straight tip, with cut-off hole, WL 15 cm, 6 Fr.
Saugkanüle nach Frazier, gerades Ende, mit Unterbrecherloch, NL 15 cm, 6 Charr.

250106FX	straight tip, with cut-off hole / WL 15 cm, 6 Fr.	gerades Ende, mit Unterbrecherloch / NL 15 cm, 6 Charr.
250108FX	straight tip, with cut-off hole / WL 15 cm, 8 Fr.	gerades Ende, mit Unterbrecherloch / NL 15 cm, 8 Charr.
250110FX	straight tip, with cut-off hole / WL 15 cm, 10 Fr.	gerades Ende, mit Unterbrecherloch / NL 15 cm, 10 Charr.
250112FX	straight tip, with cut-off hole / WL 15 cm, 12 Fr.	gerades Ende, mit Unterbrecherloch / NL 15 cm, 12 Charr.
250115FX	straight tip, with cut-off hole / WL 15 cm, 15 Fr.	gerades Ende, mit Unterbrecherloch / NL 15 cm, 15 Charr.



110116FX **Suction Tube by Frazier**, ball point tip, with cut-off hole, WL 10 cm, 6 Fr.
Saugrohr nach Frazier, olivenförmiges Ende, mit Unterbrecherloch, NL 10 cm, 6 Charr.

110116FX	ball point tip, with cut-off hole / WL 10 cm, 6 Fr.	olivenförmiges Ende, mit Unterbrecherloch / NL 10 cm, 6 Charr.
110118FX	ball point tip, with cut-off hole / WL 10 cm, 8 Fr.	olivenförmiges Ende, mit Unterbrecherloch / NL 10 cm, 8 Charr.
110120FX	ball point tip, with cut-off hole / WL 10 cm, 10 Fr.	olivenförmiges Ende, mit Unterbrecherloch / NL 10 cm, 10 Charr.
110122FX	ball point tip, with cut-off hole / WL 10 cm, 12 Fr.	olivenförmiges Ende, mit Unterbrecherloch / NL 10 cm, 12 Charr.
110125FX	ball point tip, with cut-off hole / WL 10 cm, 15 Fr.	olivenförmiges Ende, mit Unterbrecherloch / NL 10 cm, 15 Charr.



211616FX **Nasal Cotton Applicator**, round, serrated, 15 cm
Nasenwatteträger, rund, gerieft, 15 cm

211616FX	round, serrated / 15 cm	rund, gerieft / 15 cm
211618FX	round, serrated / 18 cm	rund, gerieft / 18 cm



730116FX **Bipolar Forceps**, straight, with guiding pin, 16 cm, tip 0.5 mm
Bipolare Pinzette, gerade, mit Führungsstift, 16 cm, Spitze 0,5 mm



730116FX **730119FX** **731116FX** **731119FX** **732116FX** **732119FX**

730116FX	straight, with guiding pin / 16 cm, tip 0.5 mm	gerade, mit Führungsstift / 16 cm, Spitze 0,5 mm
730119FX	straight, with guiding pin / 19.5 cm, tip 0.5 mm	gerade, mit Führungsstift / 19,5 cm, Spitze 0,5 mm
731116FX	straight, with guiding pin / 16 cm, tip 1 mm	gerade, mit Führungsstift / 16 cm, Spitze 1 mm
731119FX	straight, with guiding pin / 19.5 cm, tip 1 mm	gerade, mit Führungsstift / 19,5 cm, Spitze 1 mm
732116FX	straight, with guiding pin / 16 cm, tip 2 mm	gerade, mit Führungsstift / 16 cm, Spitze 2 mm
732119FX	straight, with guiding pin / 19.5 cm, tip 2 mm	gerade, mit Führungsstift / 19,5 cm, Spitze 2 mm



741116FX **Bipolar Forceps**, angled, with guiding pin, 16 cm, tip 1 mm
Bipolare Pinzette, abgewinkelt, mit Führungsstift, 16 cm, Spitze 1 mm



741116FX **741119FX** **742116FX** **742119FX**

741116FX	angled, with guiding pin / 16 cm, tip 1 mm	abgewinkelt, mit Führungsstift / 16 cm, Spitze 1 mm
741119FX	angled, with guiding pin / 19.5 cm, tip 1 mm	abgewinkelt, mit Führungsstift / 19,5 cm, Spitze 1 mm
742116FX	angled, with guiding pin / 16 cm, tip 2 mm	abgewinkelt, mit Führungsstift / 16 cm, Spitze 2 mm
742119FX	angled, with guiding pin / 19.5 cm, tip 2 mm	abgewinkelt, mit Führungsstift / 19,5 cm, Spitze 2 mm



761116FX **Bipolar Forceps**, bayonet, with guiding pin, 16.5 cm, straight tip 1 mm
Bipolare Pinzette, bajonett, mit Führungsstift, 16,5 cm, gerade Spitze 1 mm



761116FX

761119FX

762119FX

761116FX	bayonet, with guiding pin / 16.5 cm, straight tip 1 mm	bajonett, mit Führungsstift / 16,5 cm, gerade Spitze 1 mm
761119FX	bayonet, with guiding pin / 19 cm, straight tip 1 mm	bajonett, mit Führungsstift / 19 cm, gerade Spitze 1 mm
762119FX	bayonet, with guiding pin / 19 cm, straight tip 2 mm	bajonett, mit Führungsstift / 19 cm, gerade Spitze 2 mm



750861FX **Bipolar Forceps**, angular, with suction, 19 cm, tip 2 mm
Bipolare Pinzette, kniegebogen, mit Saugung, 19 cm, Spitze 2 mm



726504FX **Bipolar Cable**, for ERBE, Storz, Wolf units, 4,5 m
Bipolares HF Kabel, für ERBE, Storz, Wolf Generatoren, 4,5 m



726506FX **Bipolar Cable**, for US Standard + ERBE ICC units, 4,5 m
Bipolares HF Kabel, für US Standard + ERBE ICC Generatoren, 4,5 m



726508FX **Bipolar Cable**, for Martin, Berchtold, Aesculap units, 4,5 m
Bipolares HF Kabel, für Martin, Berchtold, Aesculap Gen., 4,5 m



726516FX **Bipolar Cable**, for Valleylab, Lamidey, EMC, Bowa units, 4,5 m
Bipolares HF Kabel, für Valleylab, Lamidey, EMC, Bowa Gen., 4,5 m



222121FX

222121FX **Nasal Dressing Forceps by Hartmann**, serrated, WL 11 cm
Nasentamponzange nach Hartmann, gerieft, NL 11 cm



222216FX

222216FX **Nasal Dressing Forceps by Hartmann**, delicate, serrated, WL 7,5 cm
Nasentamponzange nach Hartmann, fein, gerieft, NL 7,5 cm



223600FX **Nasal Dressing Forceps by Westmacott**, serrated, 20 cm
Nasentamponzange nach Westmacott, gerieft, 20 cm



224100FX **Nasal Dressing Forceps by Westmacott**, extra delicate, serrated, 20 cm
Nasentamponzange nach Westmacott, extra zart, gerieft, 20 cm



840100FX **Liquid Atomizer**, complete, 30 cc
Flüssigkeitszerstäuber, komplett, 30 ccm



840101FX **Spare Bottle**, brown, for 840100FX, 30 cc
Ersatzflasche, braun, für 840100FX, 30 ccm



840200FX **Liquid Atomizer**, complete (but without rubber bulb)
Flüssigkeitszerstäuber, komplett (aber ohne Gummiball)



840300FX **Rubber Bulb**, for 840100FX
Gummiball, für 840100FX



210300FX **Nasal Snare by Lange-Wilde**, bayonet-shaped, 25 cm
Nasenpolypenschnürer nach Lange-Wilde, bajonettförmig, 25 cm



210600FX **Nasal Snare by Krause**, 25 cm
Nasenpolypenschnürer nach Krause, 25 cm



211100FX **Nasal Snare Wire**, for 210300FX + 600FX, pack of 12 pcs., 10 cm, Ø 0.3 mm
Drahtschlinge, für 210300FX + 600FX, Packung zu 12 Stück, 10 cm, Ø 0.3 mm

211100FX for 210300FX + 600FX, pack of 12 pcs. / 10 cm, Ø 0.3 mm
für 210300FX + 600FX, Packung zu 12 Stück / 10 cm, Ø 0.3 mm

211135FX for 210300FX + 600FX, pack of 12 pcs. / 10 cm, Ø 0.35 mm
für 210300FX + 600FX, Packung zu 12 Stück / 10 cm, Ø 0.35 mm

211203FX for 210300FX + 600FX, pack of 100 pcs. / 10 cm, Ø 0.3 mm
für 210300FX + 600FX, Packung zu 100 Stück / 10 cm, Ø 0.3 mm



226300FX

226300FX **Nasal Scissors**, straight, serrated, WL 13 cm
Nasenschere, gerade, gezahnt, NL 13 cm

226300FX straight, serrated / WL 13 cm
gerade, gezahnt / NL 13 cm

226300FXF straight, serrated / WL 13 cm, with flush connector
gerade, gezahnt / NL 13 cm, mit Spülanschluss

226301FX curved left, serrated / WL 13 cm
links gebogen, gezahnt / NL 13 cm

226301FXF curved left, serrated / WL 13 cm, with flush connector
links gebogen, gezahnt / NL 13 cm, mit Spülanschluss

226302FX curved right, serrated / WL 13 cm
rechts gebogen, gezahnt / NL 13 cm

226302FXF curved right, serrated / WL 13 cm, with flush connector
rechts gebogen, gezahnt / NL 13 cm, mit Spülanschluss

226303FX curved up, serrated / WL 13 cm
aufwärts gebogen, gezahnt / NL 13 cm

226304FX curved down, serrated / WL 13 cm
abwärts gebogen, gezahnt / NL 13 cm



226400FX

226400FX **Nasal Scissors**, straight, smooth, WL 11.5 cm
Nasenschere, gerade, glatt, NL 11,5 cm

226400FX	straight, smooth / WL 11.5 cm	gerade, glatt / NL 11,5 cm
226401FX	curved left, smooth / WL 11.5 cm	links gebogen, glatt / NL 11,5 cm
226402FX	curved right, smooth / WL 11.5 cm	rechts gebogen, glatt / NL 11,5 cm



226100FX

226100FX **Nasal Scissors by Heymann**, standard, smooth blades, WL 9.5 cm
Nasenschere nach Heymann, Standard, glatte Schneiden, NL 9,5 cm

226100FX	standard, smooth blades / WL 9.5 cm	Standard, glatte Schneiden / NL 9,5 cm
226109FX	small, smooth blades / WL 9 cm	klein, glatte Schneiden / NL 9 cm
226111FX	large, smooth blades / WL 11 cm	groß, glatte Schneiden / NL 11 cm
226200FX	standard, serrated blades / WL 9.5 cm	Standard, gezahnte Schneiden / NL 9,5 cm
226201FX	small, curved left, smooth blades / WL 9.5 cm	klein, links gebogen, glatte Schneiden / NL 9,5 cm
226202FX	small, curved right, smooth blades / WL 9.5 cm	klein, rechts gebogen, glatte Schneiden / NL 9,5 cm



227600FX



227600FX **Nasal Cutting Forceps by Struycken**, WL 11 cm
Conchotom nach Struycken, NL 11 cm



228100FX **Nasal Cutting Forceps by Schmeden**, through-cutting, WL 12 cm, size 0
Conchotom nach Schmeden, durchschneidend, NL 12 cm, Fig. 0

228100FX	through-cutting / WL 12 cm, size 0	durchschneidend / NL 12 cm, Fig. 0
228101FX	through-cutting / WL 12 cm, size 1	durchschneidend / NL 12 cm, Fig. 1
228102FX	through-cutting / WL 12 cm, size 2	durchschneidend / NL 12 cm, Fig. 2



228100FX



228101FX



228102FX



228601FX **Nasal Cutting Forceps by Gruenwald-Henke**, through-cutting, WL 11 cm, size 1
Conchotom nach Grünwald-Henke, durchschneidend, NL 11 cm, Fig. 1

228601FX	through-cutting / WL 11 cm, size 1	durchschneidend / NL 11 cm, Fig. 1
228602FX	through-cutting / WL 11 cm, size 2	durchschneidend / NL 11 cm, Fig. 2
228603FX	through-cutting / WL 11 cm, size 3	durchschneidend / NL 11 cm, Fig. 3



228601FX



228602FX



228603FX



229101FX

229101FX **Nasal Cutting Forceps by Hartmann**, round, with grid, WL 11 cm, size 1
Conchotom nach Hartmann, rund, mit Fanggitter, NL 11 cm, Fig. 1

229101FX	round, with grid / WL 11 cm, size 1 rund, mit Fanggitter / NL 11 cm, Fig. 1	⊗
229102FX	round, with grid / WL 11 cm, size 2 rund, mit Fanggitter / NL 11 cm, Fig. 2	⊗
229103FX	round, with grid / WL 11 cm, size 3 rund, mit Fanggitter / NL 11 cm, Fig. 3	⊗
229104FX	round, with grid / WL 11 cm, size 4 rund, mit Fanggitter / NL 11 cm, Fig. 4	⊗



227100FX **Nasal Forceps by Takahashi**, straight, WL 12.5 cm, spoon 10 x 2,5 mm
Nasenzange nach Takahashi, gerade, NL 12,5 cm, Löffel 10 x 2,5 mm

227100FX	straight / WL 12.5 cm, spoon 10 x 2,5 mm	gerade / NL 12,5 cm, Löffel 10 x 2,5 mm
227101FX	straight / WL 12.5 cm, spoon 10 x 3 mm	gerade / NL 12,5 cm, Löffel 10 x 3 mm
227102FX	45° upturned / WL 12.5 cm, spoon 10 x 3 mm	45° aufgebogen / NL 12,5 cm, Löffel 10 x 3 mm



227100FX



227101FX



227102FX



230400FX



230400FX **Nasal Forceps by Struempel-Voss**, 45° upturned, extra delicate, WL 12 cm
Nasenzange nach Struempel-Voss, 45° aufgebogen, extra zart, NL 12 cm



230100FX **Nasal Forceps by Blakesley**, straight, WL 11 cm, size 0
Nasenzange nach Blakesley, gerade, NL 11 cm, Fig. 0



Pattern Schneide	Size Fig.	0°	45°	90°
	0 = 3,0 mm	230100FX	230200FX	230300FX
	1 = 3,5 mm	230101FX	230201FX	230301FX
	2 = 4,0 mm	230102FX	230202FX	230302FX
	3 = 5,0 mm	230103FX	230203FX	230303FX
	4 = 5,5 mm	230104FX	230204FX	-

230100FX	straight / WL 11 cm, size 0	gerade / NL 11 cm, Fig. 0
230101FX	straight / WL 11 cm, size 1	gerade / NL 11 cm, Fig. 1
230102FX	straight / WL 11 cm, size 2	gerade / NL 11 cm, Fig. 2
230103FX	straight / WL 11 cm, size 3	gerade / NL 11 cm, Fig. 3
230104FX	straight / WL 11 cm, size 4	gerade / NL 11 cm, Fig. 4



230200FX	45° upturned / WL 11 cm, size 0	45° aufgebogen / NL 11 cm, Fig. 0
230201FX	45° upturned / WL 11 cm, size 1	45° aufgebogen / NL 11 cm, Fig. 1
230202FX	45° upturned / WL 11 cm, size 2	45° aufgebogen / NL 11 cm, Fig. 2
230203FX	45° upturned / WL 11 cm, size 3	45° aufgebogen / NL 11 cm, Fig. 3
230204FX	45° upturned / WL 11 cm, size 4	45° aufgebogen / NL 11 cm, Fig. 4

230300FX	90° upturned / WL 11 cm, size 0	90° aufgebogen / NL 11 cm, Fig. 0
230301FX	90° upturned / WL 11 cm, size 1	90° aufgebogen / NL 11 cm, Fig. 1
230302FX	90° upturned / WL 11 cm, size 2	90° aufgebogen / NL 11 cm, Fig. 2
230303FX	90° upturned / WL 11 cm, size 3	90° aufgebogen / NL 11 cm, Fig. 3



231601FX **Nasal Forceps by Blakesley**, straight, WL 15 cm, size 1
Nasenzange nach Blakesley, gerade, NL 15 cm, Fig. 1



Pattern Schneide	Size Fig.	0°	45°	90°
	1 = 3,5 mm	231601FX	231701FX	231801FX
	2 = 4,0 mm	231602FX	231702FX	231802FX
	3 = 5,0 mm	231603FX	-	-

231601FX	straight / WL 15 cm, size 1	gerade / NL 15 cm, Fig. 1
231602FX	straight / WL 15 cm, size 2	gerade / NL 15 cm, Fig. 2
231603FX	straight / WL 15 cm, size 3	gerade / NL 15 cm, Fig. 3
231701FX	45° upturned / WL 15 cm, size 1	45° aufgebogen / NL 15 cm, Fig. 1
231702FX	45° upturned / WL 15 cm, size 2	45° aufgebogen / NL 15 cm, Fig. 2
231801FX	90° upturned / WL 15 cm, size 1	90° aufgebogen / NL 15 cm, Fig. 1
231802FX	90° upturned / WL 15 cm, size 2	90° aufgebogen / NL 15 cm, Fig. 2

Rhinology
Rhinologie



226901FX



226901FX **Nasal Forceps**, straight, through cutting, small, WL 14 cm
Nasenzange, gerade, durchschneidend, klein, NL 14 cm



226902FX



226902FX **Nasal Forceps**, 45° upturned, through-cutting, small, WL 14 cm
Nasenzange, 45° aufgebogen, durchschneidend, klein, NL 14 cm



226903FX



226903FX **Nasal Forceps**, shaft curved up, through-cutting, small, WL 14 cm
Nasenzange, Schaft aufgebog., durchschneidend, klein, NL 14 cm



226915FX



226915FX

Nasal Forceps, 45° upturned, through-cutting, small, WL 14 cm
Nasenzange, 45° aufgebogen, durchschneidend, klein, NL 14 cm



226904FX



226904FX

Nasal Spoon Forceps, straight, oval cup, WL 14 cm
Nasenlöffelzange, gerade, ovaler Löffel, NL 14 cm



226905FX



226905FX

Nasal Spoon Forceps, 45° upturned, oval cup, WL 14 cm
Nasenlöffelzange, 45° aufgebogen, ovaler Löffel, NL 14 cm

Rhinology
Rhinologie



226906FX



226906FX **Nasal Spoon Forceps**, shaft curved up, oval cup, WL 14 cm
Nasenlöffelzange, Schaft aufgebogen, ovaler Löffel, NL 14 cm



226907FX



226907FX **Nasal Forceps**, shaft curved up, backbiting, WL 14 cm
Nasenzange, Schaft aufgebogen, rückwärts schneidend, NL 14 cm



226908FX



226908FX **Nasal Forceps**, shaft curved up, through-cutting, large, WL 14 cm
Nasenzange, Schaft aufgebog., durchschneidend, groß, NL 14 cm



226909FX



226909FX **Nasal Spoon Forceps**, shaft curved up, oval cup, medium, WL 14 cm
Nasenspöfelzange, Schaft aufgebog., ovaler Löffel, mittel, NL 14 cm



226910FX



226910FX **Nasal Forceps**, straight, through-cutting, small, WL 11.5 cm
Nasenzange, gerade, durchschneidend, klein, NL 11,5 cm



226911FX



226911FX **Nasal Forceps**, straight, through-cutting, large, WL 11.5 cm
Nasenzange, gerade, durchschneidend, groß, NL 11,5 cm



226912FX

226912FX **Nasal Forceps**, 45° upturned, through-cutting, small, WL 11.5 cm
Nasenzange, 45° aufgebogen, durchschneidend, klein, NL 11,5 cm



226913FX

226913FX **Nasal Forceps**, 45° upturned, through-cutting, medium, WL 11.5 cm
Nasenzange, 45° aufgebogen, durchschneidend, mittel, NL 11,5 cm



226914FX

226914FX **Nasal Forceps**, 45° upturned, through-cutting, large, WL 11.5 cm
Nasenzange, 45° aufgebogen, durchschneidend, groß, NL 11,5 cm

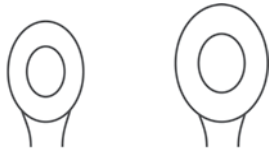

231101FX **231102FX**



231101FX **Septum Forceps by Luc**, 20.5 cm, size 1
Septumzange nach Luc, 20,5 cm, Fig. 1

231102FX **Septum Forceps by Luc**, 20.5 cm, size 2
Septumzange nach Luc, 20,5 cm, Fig. 2



232101FX **Septum Forceps by Bruenings**, 19 cm, WL 11 cm, size 1
Septumzange nach Bruenings, 19 cm, NL 11 cm, Fig. 1

232101FX	19 cm, WL 11 cm, size 1	19 cm, NL 11 cm, Fig. 1
232102FX	19 cm, WL 11 cm, size 2	19 cm, NL 11 cm, Fig. 2
232103FX	19 cm, WL 11 cm, size 3	19 cm, NL 11 cm, Fig. 3
232104FX	19 cm, WL 11 cm, size 4	19 cm, NL 11 cm, Fig. 4



232101FX



232102FX



232103FX



232104FX



233100FX **Septum Forceps by Craig**, straight, cupped jaws, sharp, 18 cm, WL 9 cm
Septumzange nach Craig, gerader Löffel, scharf, 18 cm, NL 9 cm

233200FX **Septum Forceps by Craig-Domnick**, curved, cupped jaws, sharp, 18 cm, WL 9 cm
Septumzange nach Craig-Domnick, gebogener Löffel, scharf, 18 cm, NL 9 cm



233100FX



233200FX



233300FX **Septum Forceps by Knight**, 18 cm, WL 10 cm
Septumzange nach Knight, 18 cm, NL 10 cm



235600FX



235600FX **Septum Forceps by Jansen**, with spoon, 18 cm
Septumzange nach Jansen, mit Löffel, 18 cm



235700FX



235700FX **Septum Forceps by Jansen-Middleton**, through-cutting, 19 cm
Septumzange nach Jansen-Middleton, durchschneidend, 19 cm



341600FX **Septum Scissors by Becker**, angled, double-action, 18 cm
Septumschere nach Becker, abgewinkelt, mit Doppelgelenk, 18 cm



342100FX **Septum Morcelizer by Rubin**, double-action, 19 cm
Knorpelquetschzange nach Rubin, mit Doppelgelenk, 19 cm



340100FX **Bone Cutting Forceps by Cottle-Kazanjan**, 18,5 cm
Knochensplitterzange n. Cottle-Kazanjan, 18,5 cm



340600FX **Nasal Scissors by Caplan**, angled, serrated, double-action, 22 cm
Nasenschere nach Caplan, abgewinkelt, gezahnt, mit Doppelgelenk, 22 cm



340800FX **Nasal Hump Rongeur by Rowland**, straight, double-action, 18 cm
Nasenzange nach Rowland, gerade, mit Doppelgelenk, 18 cm



108101FX **Raspatory by Lempert**, slightly curved, 17 cm, width 2 mm
Raspatorium nach Lempert, leicht gebogen, 17 cm, Breite 2 mm

108101FX	slightly curved / 17 cm, width 2 mm	leicht gebogen / 17 cm, Breite 2 mm
108102FX	slightly curved / 17 cm, width 3 mm	leicht gebogen / 17 cm, Breite 3 mm
108103FX	slightly curved / 17 cm, width 4 mm	leicht gebogen / 17 cm, Breite 4 mm
108104FX	slightly curved / 17 cm, width 5 mm	leicht gebogen / 17 cm, Breite 5 mm
108107FX	slightly curved / 17 cm, width 7 mm	leicht gebogen / 17 cm, Breite 7 mm



213100FX **Mucosa Knife by Freer**, 15 cm
Mukosamesser nach Freer, 15 cm



214100FX **Septum Knife by Freer**, 19 cm
Septummesser nach Freer, 19 cm



215100FX **Elevator by Freer**, double-ended, semi-sharp / blunt, 19 cm
Doppelelevatorium nach Freer, halbscharf / stumpf, 19 cm

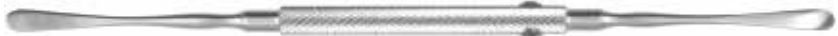

215200FX **Elevator by Freer**, double-ended, sharp / blunt, 18 cm
Doppelelevatorium nach Freer, scharf / stumpf, 18 cm



215215FX **Elevator by Weiss**, double-ended, blunt / blunt
Doppelelevatorium nach Weiss, stumpf / stumpf



215300FX **Raspatory by Freer**, curved, 16.5 cm
Raspatorium nach Freer, gebogen, 16,5 cm

Rhinology
Rhinologie



- 215310FX** **Elevator**, angled end, 16.5 cm, width 4 mm
Elevatorium, vorne abgewinkelt, 16,5 cm, Breite 4 mm



- 215700FX** **Elevator by Freer-Joseph**, double-ended, slender, 20 cm
Doppelevatorium nach Freer-Joseph, schlank, 20 cm



- 216100FX** **Elevator by Killian**, double-ended, sharp / blunt, 18 cm
Doppelevatorium nach Killian, scharf / stumpf, 18 cm

- 216200FX** **Elevator by Killian**, double-ended, sharp / blunt, 23 cm
Doppelevatorium nach Killian, scharf / stumpf, 23 cm



216600FX **Raspatory by Cottle**, slightly curved, 20 cm, width 8 mm
Raspatorium nach Cottle, leicht gebogen, 20 cm, Breite 8 mm



219101FX **Swivel Knife by Ballenger**, bayonet-shaped, 19.5 cm, width 3 mm
Schwingmesser nach Ballenger, bajonettförmig, 19,5 cm, Breite 3 mm



219102FX **Swivel Knife by Ballenger**, bayonet-shaped, 19.5 cm, width 4 mm
Schwingmesser nach Ballenger, bajonettförmig, 19,5 cm, Breite 4 mm



220101FX

220101FX **Chisel by Freer**, straight, 18.5 cm, width 4 mm
Flachmeißel nach Freer, gerade, 18,5 cm, Breite 4 mm



220102FX

220102FX **Chisel by Freer**, slightly curved, 18.5 cm, width 4 mm
Flachmeißel nach Freer, leicht gebogen, 18,5 cm, Breite 4 mm



221100FX

221100FX **Septum Gouge by Killian-Claus**, bayonet-shaped, 16.5 cm, width 5 mm
Septummeißel nach Killian-Claus, bajonettförmig, 16,5 cm, Breite 5 mm



221200FX

221200FX **Septum Gouge by Killian-Claus**, bayonet-shaped, V-shaped blade, 16.5 cm, width 5 mm
Septummeißel nach Killian-Claus, bajonettförmig, mit Kerbe, 16,5 cm, Breite 5 mm



302103FX

302103FX **Elevator by McKenty**, 14.5 cm, width 3 mm
Elevatorium nach McKenty, 14,5 cm, Breite 3 mm

302103FX	14.5 cm, width 3 mm	14,5 cm, Breite 3 mm
302104FX	14.5 cm, width 4 mm	14,5 cm, Breite 4 mm
302105FX	14.5 cm, width 5 mm	14,5 cm, Breite 5 mm



302600FX **Elevator by McKenty**, double-ended, 22 cm
Doppelelevatorium nach McKenty, 22 cm



304600FX **Elevator by Cottle**, double-ended, blunt / blunt, graduated, 23 cm
Doppelelevatorium nach Cottle, stumpf / stumpf, graduiert, 23 cm



304900FX **Elevator by Cottle**, double-ended, sharp / blunt, graduated, 20 cm
Doppelelevatorium nach Cottle, scharf / stumpf, graduiert, 20 cm

Rhinology
Rhinologie



305100FX **Elevator by Masing**, double-ended, sharp / blunt, graduated, 21.5 cm
Doppelelevatorium nach Masing, scharf / stumpf, graduiert, 21,5 cm



305600FX **Elevator by Cottle**, double-ended, strong and slight curve, 22.5 cm
Doppelelevatorium nach Cottle, starke und schwache Biegung, 22,5 cm



305700FX **Elevator by Pennington**, double-ended, right and left curve, 20 cm
Doppelelevatorium nach Pennington, rechte und linke Biegung, 20 cm



305900FX **Suction Elevator by Gorney**, with Mandrin, 21.5 cm
Saugelevatorium nach Gorney, mit Mandrin, 21,5 cm



360100FX

360100FX **Suction Elevator by Guillen**, straight tip, 20 cm
Saugelevatorium nach Guillen, Spitze gerade, 20 cm



303900FX **Oil Whetstone „Arkansas“**, wedge-shaped
Abziehstein „Arkansas“, keilförmig

Rhinology
Rhinologie



307104FX

307104FX **Chisel by Cottle**, straight, graduated, 18.5 cm, width 4 mm
Meißel nach Cottle, gerade, graduert, 18,5 cm, Breite 4 mm

307104FX	straight, graduated / 18.5 cm, width 4 mm	gerade, graduert / 18,5 cm, Breite 4 mm
307107FX	straight, graduated / 18.5 cm, width 7 mm	gerade, graduert / 18,5 cm, Breite 7 mm
307109FX	straight, graduated / 18.5 cm, width 9 mm	gerade, graduert / 18,5 cm, Breite 9 mm
307112FX	straight, graduated / 18.5 cm, width 12 mm	gerade, graduert / 18,5 cm, Breite 12 mm



307206FX **Chisel by Cottle**, curved, graduated, 18.5 cm, width 6 mm
Meißel nach Cottle, gebogen, graduert, 18,5 cm, Breite 6 mm



307304FX

307304FX **Osteotome by Cottle**, straight, graduated, 18.5 cm, width 4 mm
Osteotom nach Cottle, gerade, graduert, 18,5 cm, Breite 4 mm

307304FX	straight, graduated / 18.5 cm, width 4 mm	gerade, graduert / 18,5 cm, Breite 4 mm
307306FX	straight, graduated / 18.5 cm, width 6 mm	gerade, graduert / 18,5 cm, Breite 6 mm
307307FX	straight, graduated / 18.5 cm, width 7 mm	gerade, graduert / 18,5 cm, Breite 7 mm
307309FX	straight, graduated / 18.5 cm, width 9 mm	gerade, graduert / 18,5 cm, Breite 9 mm
307312FX	straight, graduated / 18.5 cm, width 12 mm	gerade, graduert / 18,5 cm, Breite 12 mm



307502FX



307502FX **Chisel by Cottle**, straight, graduated, with crossbar, 18.5 cm, width 2 mm
Meißel nach Cottle, gerade, graduiert, mit Griffbalken, 18,5 cm, Breite 2 mm

307502FX straight, graduated, with crossbar / 18.5 cm, width 2 mm
gerade, graduiert, mit Griffbalken / 18,5 cm, Breite 2 mm

307504FX straight, graduated, with crossbar / 18.5 cm, width 4 mm
gerade, graduiert, mit Griffbalken / 18,5 cm, Breite 4 mm

307507FX straight, graduated, with crossbar / 18.5 cm, width 7 mm
gerade, graduiert, mit Griffbalken / 18,5 cm, Breite 7 mm

307509FX straight, graduated, with crossbar / 18.5 cm, width 9 mm
gerade, graduiert, mit Griffbalken / 18,5 cm, Breite 9 mm

307512FX straight, graduated, with crossbar / 18.5 cm, width 12 mm
gerade, graduiert, mit Griffbalken / 18,5 cm, Breite 12 mm

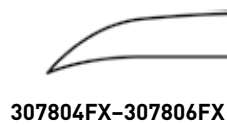
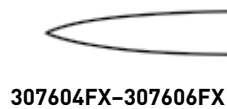

307604FX **Osteotome by Cottle**, straight, graduated, with crossbar, 18.5 cm, width 4 mm
Osteotom nach Cottle, gerade, graduiert, mit Griffbalken, 18,5 cm, Breite 4 mm

307604FX straight, graduated, with crossbar / 18.5 cm, width 4 mm
gerade, graduiert, mit Griffbalken / 18,5 cm, Breite 4 mm

307606FX straight, graduated, with crossbar / 18.5 cm, width 6 mm
gerade, graduiert, mit Griffbalken / 18,5 cm, Breite 6 mm

307804FX curved, graduated, with crossbar / 18.5 cm, width 4 mm
gebogen, graduiert, mit Griffbalken / 18,5 cm, Breite 4 mm

307806FX curved, graduated, with crossbar / 18.5 cm, width 6 mm
gebogen, graduiert, mit Griffbalken / 18,5 cm, Breite 6 mm



310600FX **Osteotome by Cottle**, graduated, single-guarded, 18.5 cm, width 5 mm
Osteotom nach Cottle, einseitiger Schutzdorn, graduiert, 18,5 cm, Breite 5 mm



310605FX **Osteotome by Cottle**, graduated, single-guarded, with crossbar, 18.5 cm, width 5 mm
Osteotom nach Cottle, einseitiger Schutzdorn + Griffbalken, graduiert, 18,5 cm, Breite 5 mm



310610FX **Osteotome by Cottle**, graduated, double-guarded, with crossbar, 18.5 cm, width 10 mm
Osteotom nach Cottle, beidseitiger Schutzdorn + Griffbalken, graduiert, 18,5 cm, Breite 10 mm

310610FX graduated, double-guarded, with crossbar / 18.5 cm, width 10 mm
 beidseitiger Schutzdorn + Griffbalken / graduiert, 18,5 cm, Breite 10 mm

310612FX graduated, double-guarded, with crossbar / 18.5 cm, width 12 mm
 beidseitiger Schutzdorn + Griffbalken / graduiert, 18,5 cm, Breite 12 mm

310614FX graduated, double-guarded, with crossbar / 18.5 cm, width 14 mm
 beidseitiger Schutzdorn + Griffbalken / graduiert, 18,5 cm, Breite 14 mm

310616FX graduated, double-guarded, with crossbar / 18.5 cm, width 16 mm
 beidseitiger Schutzdorn + Griffbalken / graduiert, 18,5 cm, Breite 16 mm



310610FX



310612FX



310614FX



310616FX



306404FX **Chisel by Peck**, 15 cm, width 4 mm
Meißel nach Peck, 15 cm, Breite 4 mm



307702FX **Osteotome by Sheehan**, straight, hexagonal handle, 16 cm, width 2 mm
Osteotom nach Sheehan, gerade, Sechskantgriff, 16 cm, Breite 2 mm

307702FX	straight, hexagonal handle / 16 cm, width 2 mm	gerade, Sechskantgriff / 16 cm, Breite 2 mm
307703FX	straight, hexagonal handle / 16 cm, width 3 mm	gerade, Sechskantgriff / 16 cm, Breite 3 mm
307704FX	straight, hexagonal handle / 16 cm, width 4 mm	gerade, Sechskantgriff / 16 cm, Breite 4 mm
307705FX	straight, hexagonal handle / 16 cm, width 5 mm	gerade, Sechskantgriff / 16 cm, Breite 5 mm
307706FX	straight, hexagonal handle / 16 cm, width 6 mm	gerade, Sechskantgriff / 16 cm, Breite 6 mm
307707FX	straight, hexagonal handle / 16 cm, width 7 mm	gerade, Sechskantgriff / 16 cm, Breite 7 mm
307708FX	straight, hexagonal handle / 16 cm, width 8 mm	gerade, Sechskantgriff / 16 cm, Breite 8 mm
307709FX	straight, hexagonal handle / 16 cm, width 9 mm	gerade, Sechskantgriff / 16 cm, Breite 9 mm
307710FX	straight, hexagonal handle / 16 cm, width 10 mm	gerade, Sechskantgriff / 16 cm, Breite 10 mm
307711FX	straight, hexagonal handle / 16 cm, width 11 mm	gerade, Sechskantgriff / 16 cm, Breite 11 mm
307712FX	straight, hexagonal handle / 16 cm, width 12 mm	gerade, Sechskantgriff / 16 cm, Breite 12 mm



307702FX



307703FX



307704FX



307705FX



307706FX



307707FX



307708FX



307709FX



307710FX



307711FX



307712FX



310800FX **Osteotome „Model Würzburg“**, curved, with double guard, 18 cm, width 3 mm
Osteotom „Würzburger Modell“, gebogen, mit beidseitigem Schutzdorn, 18 cm, Breite 3 mm



310800FX



310801FX



310802FX

310800FX	curved, with double guard / 18 cm, width 3 mm	gebogen, mit beidseitigem Schutzdorn / 18 cm, Breite 3 mm
310801FX	curved, with single guard left / 18 cm, width 3 mm	gebogen, mit Schutzdorn links / 18 cm, Breite 3 mm
310802FX	curved, with single guard right / 18 cm, width 3 mm	gebogen, mit Schutzdorn rechts / 18 cm, Breite 3 mm



307402FX **Mini-Osteotome**, straight, 12.5 cm, width 2 mm
Mini-Osteotom, gerade, 12,5 cm, Breite 2 mm

307402FX	straight / 12.5 cm, width 2 mm	gerade / 12,5 cm, Breite 2 mm
307404FX	straight / 12.5 cm, width 4 mm	gerade / 12,5 cm, Breite 4 mm
307406FX	straight / 12.5 cm, width 6 mm	gerade / 12,5 cm, Breite 6 mm
307408FX	straight / 12.5 cm, width 8 mm	gerade / 12,5 cm, Breite 8 mm
307410FX	straight / 12.5 cm, width 10 mm	gerade / 12,5 cm, Breite 10 mm
307412FX	straight / 12.5 cm, width 12 mm	gerade / 12,5 cm, Breite 12 mm



307402FX



307404FX



307406FX



307408FX



307410FX



307412FX



307422FX **Mini-Osteotome**, curved, 12.5 cm, width 2 mm
Mini-Osteotom, gebogen, 12,5 cm, Breite 2 mm

307422FX	curved / 12.5 cm, width 2 mm	gebogen / 12,5 cm, Breite 2 mm
307424FX	curved / 12.5 cm, width 4 mm	gebogen / 12,5 cm, Breite 4 mm
307426FX	curved / 12.5 cm, width 6 mm	gebogen / 12,5 cm, Breite 6 mm
307428FX	curved / 12.5 cm, width 8 mm	gebogen / 12,5 cm, Breite 8 mm
307430FX	curved / 12.5 cm, width 10 mm	gebogen / 12,5 cm, Breite 10 mm
307432FX	curved / 12.5 cm, width 12 mm	gebogen / 12,5 cm, Breite 12 mm



307422FX



307424FX



307426FX



307428FX



307430FX



307432FX



307902FX **Osteotome by Converse, 18 cm, width 2 mm**
Osteotom nach Converse, 18 cm, Breite 2 mm

307902FX	18 cm, width 2 mm	18 cm, Breite 2 mm
307903FX	18 cm, width 3 mm	18 cm, Breite 3 mm
307904FX	18 cm, width 4 mm	18 cm, Breite 4 mm
307905FX	18 cm, width 5 mm	18 cm, Breite 5 mm
307906FX	18 cm, width 6 mm	18 cm, Breite 6 mm
307907FX	18 cm, width 7 mm	18 cm, Breite 7 mm
307908FX	18 cm, width 8 mm	18 cm, Breite 8 mm
307909FX	18 cm, width 9 mm	18 cm, Breite 9 mm
307910FX	18 cm, width 10 mm	18 cm, Breite 10 mm
307911FX	18 cm, width 11 mm	18 cm, Breite 11 mm
307912FX	18 cm, width 12 mm	18 cm, Breite 12 mm
307914FX	18 cm, width 14 mm	18 cm, Breite 14 mm



307902FX



307903FX



307904FX



307905FX



307906FX



307907FX



307908FX



307909FX



307910FX

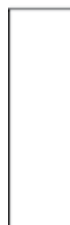

307911FX



307912FX



307914FX



308000FX **Chisel by Converse**, straight, with single guard, 19 cm, width 5 mm
Meißel nach Converse, gerade, mit einseitigem Schutzdorn, 19 cm, Breite 5 mm



308000FX	straight, with single guard / 19 cm, width 5 mm	gerade, mit einseitigem Schutzdorn / 19 cm, Breite 5 mm
308001FX	curved left, with single guard / 19 cm, width 5 mm	links geb., mit einseitigem Schutzdorn / 19 cm, Breite 5 mm
308002FX	curved right, with single guard / 19 cm, width 5 mm	rechts geb., mit einseitigem Schutzdorn / 19 cm, Breite 5 mm
308021FX	curved left, with single guard / 19 cm, width 2.2 mm	links geb., mit einseitigem Schutzdorn / 19 cm, Breite 2,2 mm
308022FX	curved right, with single guard / 19 cm, width 2.2 mm	rechts geb., mit einseitigem Schutzdorn / 19 cm, Breite 2,2 mm



306110FX **Osteotome by Rubin**, with finger grip, 16 cm, width 10 mm
Osteotom nach Rubin, mit Halteknopf, 16 cm, Breite 10 mm

306110FX	with finger grip / 16 cm, width 10 mm	mit Halteknopf / 16 cm, Breite 10 mm
306112FX	with finger grip / 16 cm, width 12 mm	mit Halteknopf / 16 cm, Breite 12 mm
306114FX	with finger grip / 16 cm, width 14 mm	mit Halteknopf / 16 cm, Breite 14 mm
306116FX	with finger grip / 16 cm, width 16 mm	mit Halteknopf / 16 cm, Breite 16 mm



306110FX



306112FX



306114FX



306116FX



306200FX

306200FX **Gouge by Rubin**, double-guarded, with finger grip, 16 cm
Hohlmeißel nach Rubin, beidseitiger Schutzdorn, mit Halteknopf, 16 cm



306610FX **Osteotome by Cinelli**, double-guarded, 16 cm, width 10 mm
Osteotom nach Cinelli, beidseitiger Schutzdorn, 16 cm, Breite 10 mm

306610FX	double-guarded / 16 cm, width 10 mm	beidseitiger Schutzdorn / 16 cm, Breite 10 mm
306612FX	double-guarded / 16 cm, width 12 mm	beidseitiger Schutzdorn / 16 cm, Breite 12 mm
306614FX	double-guarded / 16 cm, width 14 mm	beidseitiger Schutzdorn / 16 cm, Breite 14 mm
306616FX	double-guarded / 16 cm, width 16 mm	beidseitiger Schutzdorn / 16 cm, Breite 16 mm



306610FX



306612FX



306614FX



306616FX

Rhinology
Rhinologie



309630FX **Gouge by Walter**, 19 cm, width 3 mm
Hohlmeißel nach Walter, 19 cm, Breite 3 mm

309630FX	19 cm, width 3 mm	19 cm, Breite 3 mm
309645FX	19 cm, width 4.5 mm	19 cm, Breite 4,5 mm



309630FX



309645FX



309702FX **Osteotome by Walter**, 19 cm, width 2 mm
Osteotom nach Walter, 19 cm, Breite 2 mm

309702FX	19 cm, width 2 mm	19 cm, Breite 2 mm
309703FX	19 cm, width 3 mm	19 cm, Breite 3 mm
309704FX	19 cm, width 4 mm	19 cm, Breite 4 mm
309707FX	19 cm, width 7 mm	19 cm, Breite 7 mm
309709FX	19 cm, width 9 mm	19 cm, Breite 9 mm
309712FX	19 cm, width 12 mm	19 cm, Breite 12 mm



309702FX



309703FX



309704FX



309707FX



309709FX



309712FX



310100FX **Chisel by Masing**, straight, with single guard, 18 cm
Meißel nach Masing, gerade, mit einseitigem Schutzdorn, 18 cm



310100FX



310101FX



310102FX

310100FX	straight, with single guard / 18 cm	gerade, mit einseitigem Schutzdorn / 18 cm
310101FX	curved left, with single guard / 18 cm	links geb., mit einseitigem Schutzdorn / 18 cm
310102FX	curved right, with single guard / 18 cm	rechts geb., mit einseitigem Schutzdorn / 18 cm

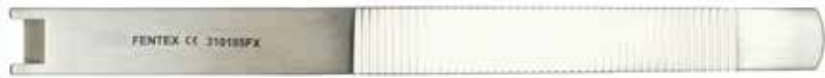

310105FX **Chisel by Masing**, straight, with double guard, 16 cm, width 10 mm
Meißel nach Masing, gerade, mit beidseitigem Schutzdorn, 16 cm, Breite 10 mm



312100FX **Osteotome by Neivert**, straight, 20.5 cm
Osteotom nach Neivert, gerade, 20,5 cm



312101FX



312102FX

312100FX	straight / 20.5 cm	gerade / 20,5 cm
312101FX	curved left / 20.5 cm	links gebogen / 20,5 cm
312102FX	curved right / 20.5 cm	rechts gebogen / 20,5 cm



312600FX **Osteotome by Silver**, straight, with single guard, 18.5 cm
Osteotom nach Silver, gerade, mit einseitigem Schutzdorn, 18,5 cm



312601FX



312602FX

312600FX	straight, with single guard / 18.5 cm	gerade, mit einseitigem Schutzdorn / 18,5 cm
312601FX	curved left, with single guard / 18.5 cm	links geb., mit einseitigem Schutzdorn / 18,5 cm
312602FX	curved right, with single guard / 18.5 cm	rechts geb., mit einseitigem Schutzdorn / 18,5 cm



130100FX **Mallet by Hajek**, steel, solid, 20 cm, 200 g
Hammer nach Hajek, Stahl, massiv, 20 cm, 200 g



313100FX **Mallet by Cottle**, black handle, 18 cm, 335 g
Hammer nach Cottle, schwarzer Griff, 18 cm, 335 g



313600FX **Metal Mallet**, with replaceable nylon facings, 18 cm, 220 g
Metallhammer, mit auswechselbaren Kunststoffbacken, 18 cm, 220 g



313601FX **Spare Nylon Facings**, pair, for mallet 313600FX
Nylon-Ersatzbacken, Paar, für Hammer 313600FX



329500FX **Scalpel Handle by Masing**, 14 cm
Skalpellogriff nach Masing, 14 cm



329103FX **Scalpel Handle**, for Scalpel Blades Fig. 10-15, No. 3
Skalpellogriff, passend für Skalpelloklingen Fig. 10-15, Nr. 3



329107FX **Scalpel Handle**, for Scalpel Blades Fig. 10-15, No. 7
Skalpellogriff, passend für Skalpelloklingen Fig. 10-15, Nr. 7

329110FX **Scalpel Blades**, sterile, pack of 100 pcs., Fig. 10
Skalpelloklingen, steril, Packung zu 100 Stück, Fig. 10

329110FX	sterile, pack of 100 pcs. / Fig. 10	steril, Packung zu 100 Stück / Fig. 10
329111FX	sterile, pack of 100 pcs. / Fig. 11	steril, Packung zu 100 Stück / Fig. 11
329115FX	sterile, pack of 100 pcs. / Fig. 15	steril, Packung zu 100 Stück / Fig. 15



329110FX



329111FX



329115FX

Rhinology
Rhinologie



329410FX **Scalpel Handle**, round, 12.5 cm
Skalpellegriff, rund, 12,5 cm

329430FX **Scalpel Handle**, round, 15 cm
Skalpellegriff, rund, 15 cm

329462FX **Mini Scalpel Blade**, sterile, pack of 25 pcs., Fig. 62
Mini-Skalpellklingen, steril, Packung zu 25 Stück, Fig. 62

329462FX	sterile, pack of 25 pcs. / Fig. 62	steril, Packung zu 25 Stück / Fig. 62
329464FX	sterile, pack of 25 pcs. / Fig. 64	steril, Packung zu 25 Stück / Fig. 64
329465FX	sterile, pack of 25 pcs. / Fig. 65	steril, Packung zu 25 Stück / Fig. 65
329467FX	sterile, pack of 25 pcs. / Fig. 67	steril, Packung zu 25 Stück / Fig. 67



329462FX



329464FX



329465FX



329467FX



303100FX **Nasal Knife by Cottle**, rounded edge, 14 cm
Septummesser nach Cottle, rund, 14 cm



332100FX **Nasal Knife by Masing**, slightly curved, rounded tip, 14 cm
Ritzmesser nach Masing, leicht gebogen, abgerundete Spitze, 14 cm



334100FX **Rhinoplastic Knife by Joseph**, straight, rounded tip, 15 cm
Nasenplastikmesser nach Joseph, gerade, abgerundete Spitze, 15 cm



335100FX



335300FX

335100FX **Rhinoplastic Knife by Joseph**, straight, sharp, 15 cm
Nasenplastikmesser nach Joseph, gerade, scharf, 15 cm

335300FX **Rhinoplastic Knife by Joseph**, straight, blunt, 15 cm
Nasenplastikmesser nach Joseph, gerade, stumpf, 15 cm

Rhinology
Rhinologie



315100FX



315200FX



315100FX **Hook by Cottle**, angled, black finish, 14.5 cm
Häkchen nach Cottle, abgewinkelt, geschwärzt, 14,5 cm

315200FX **Hook by Cottle**, curved, black finish, 14.5 cm
Häkchen nach Cottle, rund gebogen, geschwärzt, 14,5 cm



316100FX **Hook by Cottle**, 2 prongs, right blunt, left sharp, 15 cm, width 10 mm
Häkchen nach Cottle, zweizahnig, rechts stumpf, links scharf, 15 cm, Breite 10mm



316200FX **Hook by Cottle**, 2 prongs, right sharp, left blunt, 15 cm, width 10 mm
Häkchen nach Cottle, zweizahnig, rechts scharf, links stumpf, 15 cm, Breite 10mm



316300FX **Hook by Cottle**, 2 prongs, right sharp, left sharp, 15 cm, width 10 mm
Häkchen nach Cottle, zweizahnig, beidseitig scharf, 15 cm, Breite 10mm



316400FX **Skin Hook by Gillies**, small, sharp, 1 prong, 18 cm
Hauthäkchen nach Gillies, klein, scharf, einzahnig, 18 cm



316500FX **Hook by Freer**, sharp, 2 prongs, 15 cm
Häkchen nach Freer, scharf, zweizahnig, 15 cm



316602FX **Hook by Joseph**, sharp, 2 prongs, 16 cm, width 2 mm
Häkchen nach Joseph, scharf, zweizahnig, 16 cm, Breite 2 mm

316602FX	sharp, 2 prongs / 16 cm, width 2 mm	scharf, zweizahnig / 16 cm, Breite 2 mm
316605FX	sharp, 2 prongs / 16 cm, width 5 mm	scharf, zweizahnig / 16 cm, Breite 5 mm
316607FX	sharp, 2 prongs / 16 cm, width 7 mm	scharf, zweizahnig / 16 cm, Breite 7 mm
316610FX	sharp, 2 prongs / 16 cm, width 10 mm	scharf, zweizahnig / 16 cm, Breite 10 mm
316612FX	sharp, 2 prongs / 16 cm, width 12 mm	scharf, zweizahnig / 16 cm, Breite 12 mm



316602FX



316605FX



316607FX



316610FX



316612FX

Rhinology
Rhinologie



316700FX **Nasal Hook by Fomon**, blunt, 2 prongs, 16.5 cm, width 10 mm
Nasenflügelhaken nach Fomon, stumpf, zweizahnig, 16,5 cm, Breite 10 mm



317100FX

317100FX **Skin Hook by Frazier**, sharp, 1 prong, 12.5 cm
Hauthäkchen nach Frazier, scharf, einzahnig, 12,5 cm



317200FX

317200FX **Hook by Cottle**, sharp, 1 prong, 14.5 cm
Häkchen nach Cottle, scharf, einzahnig, 14,5 cm



318100FX **Retractor by Cottle**, blunt, 4 prongs, 15 cm
Haken nach Cottle, stumpf, vierzahnig, 15 cm



319100FX **Alar Retractor by Cottle**, short blade, 14 cm
Nasenflügelhaken nach Cottle, kurzes Blatt, 14 cm



319600FX **Alar Retractor by Cottle**, with lip, 15 cm
Nasenflügelhaken nach Cottle, mit Lippe, 15 cm



320100FX **Knife Guide/Retractor by Cottle-Neivert**, large, 22 cm
Doppelhaken nach Cottle-Neivert, groß, 22 cm



320101FX **Knife Guide/Retractor by Cottle-Neivert**, small, 19 cm
Doppelhaken nach Cottle-Neivert, klein, 19 cm



320600FX **Knife Guide/Retractor by Neivert**, made of wire, 18 cm
Doppelhaken nach Neivert, aus Draht, 18 cm



464100FX **Retractor by Senn-Miller**, 3 sharp prongs, 16 cm
Wundhäkchen nach Senn-Miller, 3 scharfe Zähne, 16 cm



464200FX **Retractor by Senn-Miller**, 3 blunt prongs, 16 cm
Wundhäkchen nach Senn-Miller, 3 stumpfe Zähne, 16 cm



320700FX **Nasal Retractor by Walter**, double-ended, 12.5 cm
Doppelinstrument nach Walter, 12,5 cm



322600FX **Nasal Retractor by Aufricht**, 17 cm, blade length 60 mm
Nasenrückenhaken nach Aufricht, 17 cm, Blattlänge 60 mm

322700FX **Nasal Retractor by Aufricht**, 16 cm, blade length 45 mm
Nasenrückenhaken nach Aufricht, 16 cm, Blattlänge 45 mm



322900FX **Retractor by Cottle**, with thimble, sharp, 2 prongs, 5.5 cm, width 10 mm
Häkchen nach Cottle, mit Fingerring, scharf, zweizahnig, 5,5 cm, Breite 10 mm



324300FX **Alar Retractor by Converse**, double-ended, blunt / blunt, 2 prongs, 12 cm
Doppel-Nasenflügelhaken nach Converse, stumpf / stumpf, zweizahnig, 12 cm



324400FX **Alar Retractor by Kilner**, sharp, two prongs, 8.5 cm, width 10 mm
Nasenflügelhaken nach Kilner, scharf, zweizahnig, 8,5 cm, Breite 10 mm

324400FX	sharp, two prongs / 8.5 cm, width 10 mm	scharf, zweizahnig / 8,5 cm, Breite 10 mm
324401FX	blunt, two prongs / 8.5 cm, width 10 mm	stumpf, zweizahnig / 8,5 cm, Breite 10 mm
324402FX	sharp, two prongs / 8.5 cm, width 13 mm	scharf, zweizahnig / 8,5 cm, Breite 13 mm

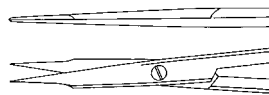

168310FX



168310FX **Scissors by Stevens**, straight, blunt, 10.5 cm
Schere nach Stevens, gerade, stumpf, 10,5 cm

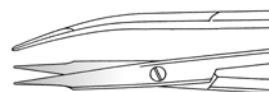

168410FX



168410FX **Scissors by Stevens**, curved, blunt, 10.5 cm
Schere nach Stevens, gebogen, stumpf, 10,5 cm

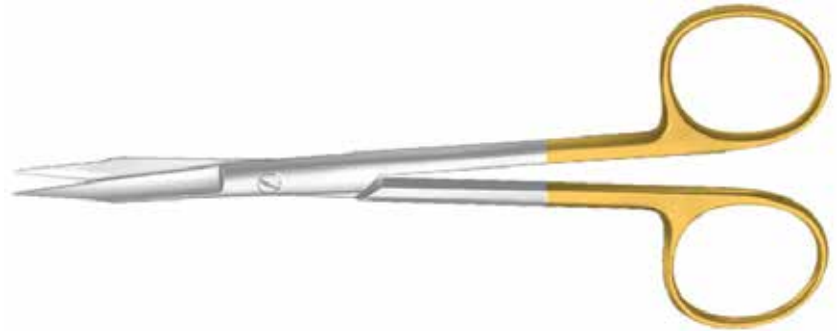

168513FX **Scissors by Goldman-Fox**, straight, bottom blade serrated, with TC, 13 cm
Schere nach Goldman-Fox, gerade, unteres Blatt gezahnt, mit TC, 13 cm

168513FX	straight, bottom blade serrated, with TC / 13 cm	gerade, unteres Blatt gezahnt, mit TC / 13 cm
168713FX	curved, bottom blade serrated, with TC / 13 cm	gebogen, unteres Blatt gezahnt, mit TC / 13 cm
168813FX	curved, Super Cut / 13 cm	gebogen, Super Cut / 13 cm

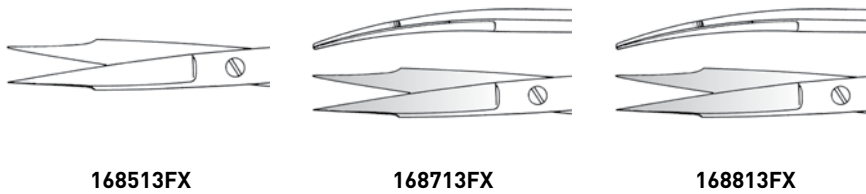

168513FX

168713FX

168813FX



112114FX **Operating Scissors by Mayo**, straight, 14.5 cm
Chirurgische Schere nach Mayo, gerade, 14,5 cm

112114FX	straight / 14.5 cm	gerade / 14,5 cm
112117FX	straight / 17 cm	gerade / 17 cm
112214FX	curved / 14.5 cm	gebogen / 14,5 cm
112217FX	curved / 17 cm	gebogen / 17 cm



176614FX **Scissors by Joseph**, straight, 14 cm
Schere nach Joseph, gerade, 14 cm

176614FX	straight / 14 cm	gerade / 14 cm
176714FX	curved / 14 cm	gebogen / 14 cm
176814FX	straight, with tungsten carbide inserts / 14 cm	gerade, mit Hartmetalleinlagen / 14 cm
176914FX	curved, with tungsten carbide inserts / 14 cm	gebogen, mit Hartmetalleinlagen / 14 cm



176614FX



176714FX

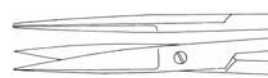

176814FX



176914FX



177110FX **Scissors**, straight, bl/bl, 10.5 cm
Schere, gerade, st/st, 10,5 cm

177110FX	straight, bl/bl / 10.5 cm	gerade, st/st / 10,5 cm
177112FX	straight, bl/bl, with TC inserts / 11.5 cm	gerade, st/st, mit Hartmetalleinlagen / 11,5 cm
177210FX	curved, bl/bl / 10.5 cm	gebogen, st/st / 10,5 cm
177212FX	curved, bl/bl, with TC inserts / 11.5 cm	gebogen, st/st, mit Hartmetalleinlagen / 11,5 cm
177312FX	straight, bl/bl / 11.5 cm	gerade, st/st / 11,5 cm
177412FX	curved, bl/bl / 11.5 cm	gebogen, st/st / 11,5 cm



179715FX-179818FX

179715FX **Dissecting Scissors by Reynolds**, curved, 15 cm
Präparierschere nach Reynolds, gebogen, 15 cm

179715FX	curved / 15 cm	gebogen / 15 cm
179718FX	curved / 18 cm	gebogen / 18 cm
179815FX	curved, Super Cut / 15 cm	gebogen, Super Cut / 15 cm
179818FX	curved, Super Cut / 18 cm	gebogen, Super Cut / 18 cm



338812FX-338913FX

338812FX **Scissors by Kilner**, curved, blunt / blunt, 11.5 cm
Schere nach Kilner, gebogen, stumpf / stumpf, 11,5 cm

338812FX	curved, blunt / blunt / 11.5 cm	gebogen, stumpf / stumpf / 11,5 cm
338814FX	curved, blunt / blunt / 14 cm	gebogen, stumpf / stumpf / 14 cm
338913FX	curved, blunt / blunt, with TC / 13 cm	gebogen, stumpf / stumpf, mit TC / 13 cm



177610FX **Scissors**, straight, sh/sh, 10.5 cm
Schere, gerade, sp/sp, 10,5 cm

177610FX	straight, sh/sh / 10.5 cm	gerade, sp/sp / 10,5 cm
177612FX	straight, sh/sh, with TC inserts / 11.5 cm	gerade, sp/sp, mit Hartmetalleinlagen / 11,5 cm
177621FX	straight, sh/sh, Super Cut / 10.5 cm	gerade, sp/sp, Super Cut / 10,5 cm
177710FX	curved, sh/sh / 10.5 cm	gebogen, sp/sp / 10,5 cm
177712FX	curved, sh/sh, with TC inserts / 11.5 cm	gebogen, sp/sp, mit Hartmetalleinlagen / 11,5 cm
177721FX	curved, sh/sh, Super Cut / 10.5 cm	gebogen, sp/sp, Super Cut / 10,5 cm
177812FX	straight, sh/sh / 11.5 cm	gerade, sp/sp / 11,5 cm
177822FX	straight, sh/sh, Super Cut / 11.5 cm	gerade, sp/sp, Super Cut / 11,5 cm
177912FX	curved, sh/sh / 11.5 cm	gebogen, sp/sp / 11,5 cm
177922FX	curved, sh/sh, Super Cut / 11.5 cm	gebogen, sp/sp, Super Cut / 11,5 cm



442114FX **Dissecting Scissors by Metzenbaum**, curved, blunt / blunt, 14.5 cm
Präparierschere nach Metzenbaum, gebogen, stumpf / stumpf, 14,5 cm

442114FX	curved, blunt / blunt / 14.5 cm	gebogen, stumpf / stumpf / 14,5 cm
442118FX	curved, blunt / blunt / 18 cm	gebogen, stumpf / stumpf / 18 cm
442120FX	curved, blunt / blunt / 20 cm	gebogen, stumpf / stumpf / 20 cm
442314FX	curved, blunt / blunt, with TC / 14.5 cm	gebogen, stumpf / stumpf, mit TC / 14,5 cm
442318FX	curved, blunt / blunt, with TC / 18 cm	gebogen, stumpf / stumpf, mit TC / 18 cm
442320FX	curved, blunt / blunt, with TC / 20 cm	gebogen, stumpf / stumpf, mit TC / 20 cm
442714FX	curved, blunt / blunt, Super Cut / 14.5 cm	gebogen, stumpf / stumpf, Super Cut / 14,5 cm
442718FX	curved, blunt / blunt, Super Cut / 18 cm	gebogen, stumpf / stumpf, Super Cut / 18 cm
442720FX	curved, blunt / blunt, Super Cut / 20 cm	gebogen, stumpf / stumpf, Super Cut / 20 cm



442214FX **Dissecting Scissors by Metzenbaum-Fino**, curved, blunt / blunt, 14.5 cm
Präparierschere nach Metzenbaum-Fino, gebogen, stumpf / stumpf, 14,5 cm

442214FX	curved, blunt / blunt / 14.5 cm	gebogen, stumpf / stumpf / 14,5 cm
442218FX	curved, blunt / blunt / 18 cm	gebogen, stumpf / stumpf / 18 cm
442220FX	curved, blunt / blunt / 20 cm	gebogen, stumpf / stumpf / 20 cm
442514FX	curved, blunt / blunt, with TC / 14.5 cm	gebogen, stumpf / stumpf, mit TC / 14,5 cm
442518FX	curved, blunt / blunt, with TC / 18 cm	gebogen, stumpf / stumpf, mit TC / 18 cm
442814FX	curved, blunt / blunt, Super Cut / 14.5 cm	gebogen, stumpf / stumpf, Super Cut / 14,5 cm
442818FX	curved, blunt / blunt, Super Cut / 18 cm	gebogen, stumpf / stumpf, Super Cut / 18 cm



177510FX **Tenotomy Scissors by Stevens**, straight, sharp, Ergo-Rings, 10 cm
Sehnenschere nach Stevens, gerade, spitz, Ergo-Ringe, 10 cm



177511FX **Tenotomy Scissors by Stevens**, curved, blunt, Ergo-Rings, 10 cm
Sehnenschere nach Stevens, gebogen, stumpf, Ergo-Ringe, 10 cm



177521FX **Tenotomy Scissors by Stevens**, curved, blunt, Ergo-Rings, Super Cut, 10 cm
Sehnenschere nach Stevens, gebogen, stumpf, Ergo-Ringe, Super Cut, 10 cm



338510FX **Scissors by Walter**, angled, 10 cm
Schere nach Walter, abgewinkelt, 10 cm



338612FX

338612FX **Scissors by Fomon**, strongly curved, 12 cm
Schere nach Fomon, stark gebogen, 12 cm



338712FX Scissors by Fomon, curved, 12 cm
Schere nach Fomon, gebogen, 12 cm



339100FX Dorsal Scissors by Fomon, angular, serrated blades, 13.5 cm
Nasenschere nach Fomon, kniegebogen, gezahnte Schneiden, 13,5 cm



339101FX Dorsal Scissors by Fomon, angular, smooth blades, 13.5 cm
Nasenschere nach Fomon, kniegebogen, glatte Schneiden, 13,5 cm



339102FX **Dorsal Scissors by Fomon**, angular, serrated blades, with TC, 13.5 cm
Nasenschere nach Fomon, kniegebogen, gezahnte Schneiden, mit TC, 13,5 cm



339103FX **Dorsal Scissors by Fomon**, angular, Super Cut version, 13.5 cm
Nasenschere nach Fomon, kniegebogen, Super Cut Ausführung, 13,5 cm



339200FX **Dorsal Scissors by Cottle**, angular, smooth blades, 16 cm
Nasenschere nach Cottle, kniegebogen, glatte Schneiden, 16 cm



339300FX **Dorsal Scissors by Cottle**, angular, smooth blades, with TC, 16 cm
Nasenschere nach Cottle, kniegebogen, glatte Schneiden, mit TC, 16 cm



339400FX **Dorsal Scissors by Cottle**, angular, Super Cut version, 16 cm
Nasenschere nach Cottle, kniegebogen, Super Cut Ausführung, 16 cm



301100FX **Columella Forceps by Cottle, 10.5 cm**
Columella Pinzette nach Cottle, 10,5 cm



301200FX **Columella Forceps by Cottle, for children, 8.5 cm**
Columella Pinzette nach Cottle, für Kinder, 8,5 cm



325112FX **Tissue Forceps by Adson-Brown, 12 cm**
Pinzette nach Adson-Brown, 12 cm



325212FX **Dressing Forceps by Adson, 12 cm**
Anatomische Pinzette nach Adson, 12 cm



325312FX **Tissue Forceps by Adson, 12 cm, 1 x 2 teeth**
Chirurgische Pinzette nach Adson, 12 cm, 1 x 2 Zähne



325412FX

325412FX **Dressing Forceps by Micro-Adson, 12 cm**
Anatomische Pinzette nach Mikro-Adson, 12 cm



325512FX

325512FX **Tissue Forceps by Micro-Adson, 12 cm, 1 x 2 teeth**
Chirurgische Pinzette nach Mikro-Adson, 12 cm, 1 x 2 Zähne



326111FX **Fixation Forceps by Graefe**, 11 cm, 7 x 8 prongs
Fixierpinzette nach Graefe, 11 cm, 7 x 8 Zähne



326315FX **Atraumatic Forceps by Glanz**, 15 cm
Atraumatische Pinzette nach Glanz, 15 cm



327115FX **Lower Lateral Forceps by Cottle**, bayonet-shaped, serrated, with teeth, 14 cm
Nasenpinzette nach Cottle, bajonettförmig, gerieft, mit Zahnung, 14 cm



328100FX **Cartilage Forceps by Hinderer**, 12.5 cm, 2 x 2 teeth
Nasenpinzette nach Hinderer, 12,5 cm, 2 x 2 Zähne



328110FX **Suture Forceps by Castroviejo**, 10.5 cm, 1 x 2 teeth
Fadenpinzette nach Castroviejo, 10,5 cm, 1 x 2 Zähne



108712FX

108712FX **Dressing Forceps by Semken**, straight, 12.5 cm
Anatomische Pinzette nach Semken, gerade, 12,5 cm



108812FX

108812FX **Tissue Forceps by Semken**, straight, 12.5 cm, 1 x 2 teeth
Chirurgische Pinzette nach Semken, gerade, 12,5 cm, 1 x 2 Zähne



109310FX **Iris Forceps by Graefe**, straight, 10 cm
Irispinzette nach Graefe, gerade, 10 cm

109310FX	straight / 10 cm	gerade / 10 cm
109320FX	curved / 10 cm	gebogen / 10 cm
109410FX	straight / 10 cm, 1 x 2 teeth	gerade / 10 cm, 1 x 2 Zähne
109420FX	curved / 10 cm, 1 x 2 teeth	gebogen / 10 cm, 1 x 2 Zähne



109310FX



109320FX



109410FX



109420FX



109515FX **Tissue Forceps by Gillies**, 15 cm, 1 x 2 teeth
Chirurgische Pinzette nach Gillies, 15 cm, 1 x 2 Zähne



113115FX **Needle Holder by Crile-Wood**, with tungsten carbide inserts, 15 cm
Nadelhalter nach Crile-Wood, mit Hartmetalleinlagen, 15 cm

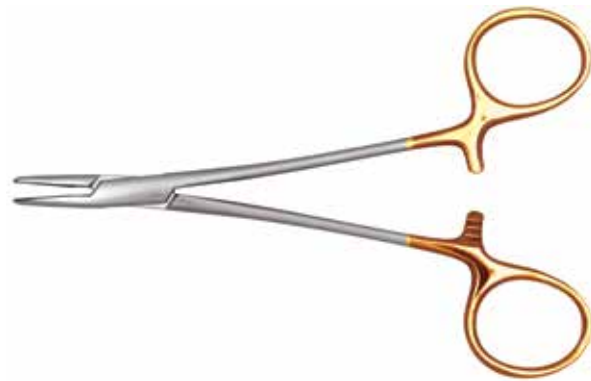

113213FX **Needle Holder by Halsey**, with tungsten carbide inserts, 13 cm
Nadelhalter nach Halsey, mit Hartmetalleinlagen, 13 cm



365113FX **Needle Holder by Neivert**, thumb ring upturned, 13 cm
Nadelhalter nach Neivert, schräger Daumenring, 13 cm

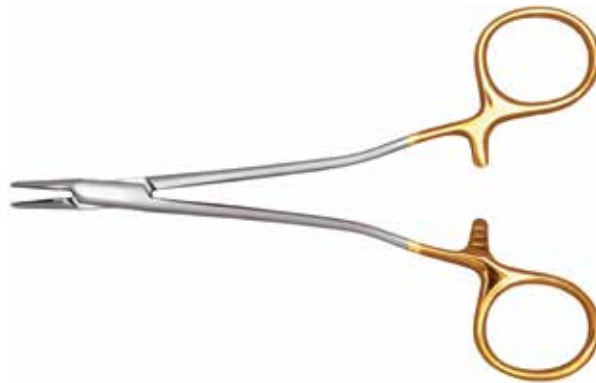

367115FX **Needle Holder by Senning**, with tungsten carbide inserts, 15 cm
Nadelhalter nach Senning, mit Hartmetalleinlagen, 15 cm

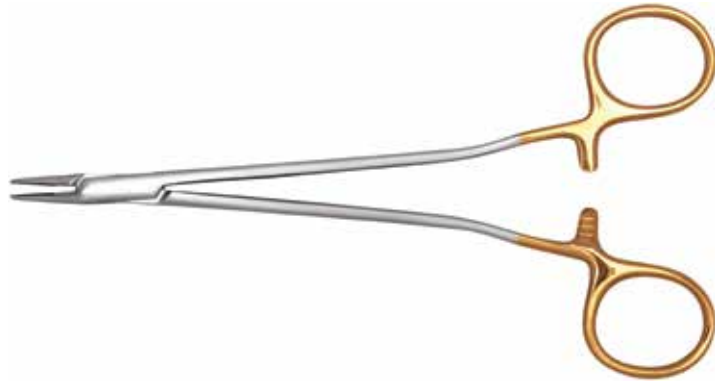

367117FX **Needle Holder by Senning**, with tungsten carbide inserts, 17 cm
Nadelhalter nach Senning, mit Hartmetalleinlagen, 17 cm



368109FX **Needle Holder by Masing-Cottle**, ear forceps shape, smooth jaws, WL 8 cm
Nadelhalter nach Masing-Cottle, Ohrzängchen-Form, glatte Maulteile, NL 8 cm



352101FX **Nasal Rasp**, double-ended, coarse, with TC, 20 cm, size 1 and 2
Knochenraspel, doppelendig, grob, mit TC, 20 cm, Fig. 1 und 2

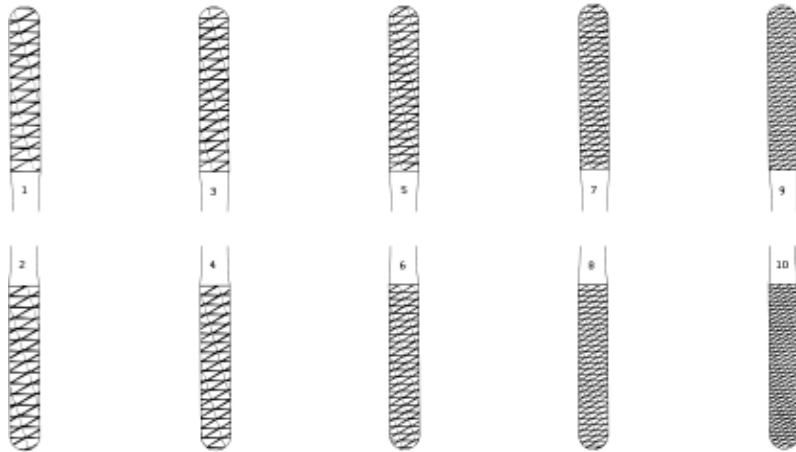

352101FX

352102FX

352103FX

352104FX

352105FX

352101FX double-ended, coarse, with TC / 20 cm, size 1 and 2
doppelendig, grob, mit TC / 20 cm, Fig. 1 und 2

352102FX double-ended, coarse and medium, with TC / 20 cm, size 3 and 4
doppelendig, grob und mittel, mit TC / 20 cm, Fig. 3 und 4

352103FX double-ended, medium, with TC / 20 cm, size 5 and 6
doppelendig, mittel, mit TC / 20 cm, Fig. 5 und 6

352104FX double-ended, medium and fine, with TC / 20 cm, size 7 and 8
doppelendig, mittel und fein, mit TC / 20 cm, Fig. 7 und 8

352105FX double-ended, fine, with TC / 20 cm, size 9 and 10
doppelendig, fein, mit TC / 20 cm, Fig. 9 und 10

Rhinology
Rhinologie



353101FX **Nasal Rasp by Parkes**, coarse, with tungsten carbide inserts, 20.5 cm, size 1
Nasenraspel nach Parkes, grob, mit Hartmetalleinlagen, 20,5 cm, Fig. 1

353101FX coarse, with tungsten carbide inserts / 20.5 cm, size 1
grob, mit Hartmetalleinlagen / 20,5 cm, Fig. 1

353102FX coarse, with tungsten carbide inserts / 20.5 cm, size 2
grob, mit Hartmetalleinlagen / 20,5 cm, Fig. 2

353103FX coarse, with tungsten carbide inserts / 20.5 cm, size 3
grob, mit Hartmetalleinlagen / 20,5 cm, Fig. 3

353104FX medium, with tungsten carbide inserts / 20.5 cm, size 4
mittel, mit Hartmetalleinlagen / 20,5 cm, Fig. 4

353105FX medium, with tungsten carbide inserts / 20.5 cm, size 5
mittel, mit Hartmetalleinlagen / 20,5 cm, Fig. 5

353106FX medium, with tungsten carbide inserts / 20.5 cm, size 6
mittel, mit Hartmetalleinlagen / 20,5 cm, Fig. 6

353107FX fine, with tungsten carbide inserts / 20.5 cm, size 7
fein, mit Hartmetalleinlagen / 20,5 cm, Fig. 7

353108FX fine, with tungsten carbide inserts / 20.5 cm, size 8
fein, mit Hartmetalleinlagen / 20,5 cm, Fig. 8



353501FX **Nasal Rasp by Maltz**, coarse, with tungsten carbide inserts, 17 cm, size 1
Nasenraspel nach Maltz, grob, mit Hartmetalleinlagen, 17 cm, Fig. 1

353501FX coarse, with tungsten carbide inserts / 17 cm, size 1 grob, mit Hartmetalleinlagen / 17 cm, Fig. 1

353502FX coarse, with tungsten carbide inserts / 17 cm, size 2 grob, mit Hartmetalleinlagen / 17 cm, Fig. 2

353503FX coarse, with tungsten carbide inserts / 17 cm, size 3 grob, mit Hartmetalleinlagen / 17 cm, Fig. 3

353504FX medium, with tungsten carbide inserts / 17 cm, size 4 mittel, mit Hartmetalleinlagen / 17 cm, Fig. 4

353505FX medium, with tungsten carbide inserts / 17 cm, size 5 mittel, mit Hartmetalleinlagen / 17 cm, Fig. 5

353506FX medium, with tungsten carbide inserts / 17 cm, size 6 mittel, mit Hartmetalleinlagen / 17 cm, Fig. 6

353507FX fine, with tungsten carbide inserts / 17 cm, size 7 fein, mit Hartmetalleinlagen / 17 cm, Fig. 7

353508FX fine, with tungsten carbide inserts / 17 cm, size 8 fein, mit Hartmetalleinlagen / 17 cm, Fig. 8



353600FX **Nasal Rasp by Maltz**, down-cutting, 2 blood grooves, 19 cm
Nasenraspel nach Maltz, auf Zug schneidend, 2 Blutrinnen, 19 cm



353800FX **Nasal Rasp by Maltz**, up-cutting, 2 blood grooves, 19 cm
Nasenraspel nach Maltz, auf Druck schneidend, 2 Blutrinnen, 19 cm



353601FX **Nasal Rasp by Maltz**, down-cutting, 2 blood grooves, TC, 16.5 cm
Nasenraspel nach Maltz, auf Zug schneidend, 2 Blutrinnen, TC, 16,5 cm



353602FX **Nasal Rasp by Maltz**, up-cutting, 2 blood grooves, TC, 16.5 cm
Nasenraspel nach Maltz, auf Druck schneidend, 2 Blutrinnen, TC, 16,5 cm



353700FX **Nasal Rasp by Maltz**, down-cutting, 2 blood grooves, 19 cm, slender model
Nasenraspel nach Maltz, auf Zug schneidend, 2 Blutrinnen, 19 cm, schlankes Modell

353900FX **Nasal Rasp by Maltz**, up-cutting, 2 blood grooves, 19 cm, slender model
Nasenraspel nach Maltz, auf Druck schneidend, 2 Blutrinnen, 19 cm, schlankes Modell



353603FX **Nasal Rasp by Miller**, double-ended, horizontal serration, TC, 16 cm, No. 1
Nasenraspel nach Miller, doppelendig, quengerieft, TC, 16 cm, Nr. 1

353604FX **Nasal Rasp by Miller**, double-ended, crossed serration, TC, 16 cm, No. 2
Nasenraspel nach Miller, doppelendig, karo-gerieft, TC, 16 cm, Nr. 2



353603FX



353604FX



353620FX **Glabella Nasal Rasp by Aufricht**, with tungsten carbide inserts, 20.5 cm
Glabella Nasenraspel nach Aufricht, mit Hartmetalleinlagen, 20,5 cm



353100FX **Nasal Rasp by Cottle-Masing**, double-ended, fine, 21.5 cm
Knochenfeile nach Cottle-Masing, doppelendig, fein, 21,5 cm



353200FX **Nasal Rasp by Cottle-Masing**, double-ended, coarse, 21.5 cm
Knochenfeile nach Cottle-Masing, doppelendig, grob, 21,5 cm



353300FX **Nasal Rasp by Kleinert-Kutz (Fomon)**, double-ended, 20 cm
Nasenraspel nach Kleinert-Kutz (Fomon), doppelendig, 20 cm



354000FX **Nasal Rasp by Joseph**, fine, 17 cm
Nasenraspel nach Joseph, fein, 17 cm



354001FX **Nasal Rasp by Joseph**, coarse, 17 cm
Nasenraspel nach Joseph, grob, 17 cm



354100FX **Nasal Rasp by Cottle**, down-cutting, 21 cm
Nasenraspel nach Cottle, auf Zug schneidend, 21 cm

Rhinology
Rhinologie



354500FX **Glabella Nasal Rasp by Aufricht**, up and down-cutting, 19 cm
Glabella Nasenraspel nach Aufricht, auf Zug und Druck schneidend, 19 cm



354600FX



354700FX

354500FX	up and down-cutting / 19 cm	auf Zug und Druck schneidend / 19 cm
354600FX	down-cutting / 21 cm	auf Zug schneidend / 21 cm
354700FX	up-cutting / 21 cm	auf Druck schneidend / 21 cm



357200FX **Nasal Rasp by Cottle**, with diamond coating, 20.5 cm
Nasenraspel nach Cottle, mit Diamantbeschichtung, 20,5 cm



357300FX **Nasal Rasp by Aufricht**, with diamond coating, 20.5 cm
Nasenraspel nach Aufricht, mit Diamantbeschichtung, 20,5 cm



357401FX **Nasal Rasp**, straight, with diamond coating, 19 cm
Nasenraspel, gerade, mit Diamantbeschichtung, 19 cm



357403FX

357403FX **Nasal Rasp**, curved backward, with diamond coating, 19 cm
Nasenraspel, rückwärts geb., mit Diamantbeschichtung, 19 cm



357500FX **Nasal Rasp by Fomon**, double-ended, with diamond coating, 21 cm
Nasenraspel nach Fomon, doppelendig, mit Diamantbeschichtung, 21 cm



311100FX **Cartilage Insertion Forceps by Cottle**, 15 cm
Knorpel einlegepinzette nach Cottle, 15 cm

Rhinology
Rhinologie



348101FX **Nasal Saw by Joseph**, bayonet-shaped, left, 18 cm
Nasensäge nach Joseph, bajonettförmig, links, 18 cm

348101FX	bayonet-shaped, left / 18 cm	bajonettförmig, links / 18 cm
348102FX	bayonet-shaped, right / 18 cm	bajonettförmig, rechts / 18 cm
348200FX	straight / 18 cm	gerade / 18 cm



350100FX **Bone & Cartilage Crusher by Cottle**, with removal clamp
Knorpel-/Knochenquetsche nach Cottle, mit Entnahmeklammer



350700FX **Bone & Cartilage Crusher by Tolsdorff**, to press pieces of bone up to Ø 4 mm
Knorpel-/Knochenquetsche nach Tolsdorff, zum Pressen von Stücken bis zu Ø 4 mm



363600FX **Ruler with mm and inch scale**, NO MEDICAL DEVICE – SCALE NOT CALIBRATED, 20 cm, flexible
Messstab mit mm und Zoll Skala, KEIN MEDIZINPRODUKT – NICHT KALIBRIERT, 20 cm, flexibel



343100FX **Septum Straightening Forceps by Walsham**, detachable, 21.5 cm
Septumrichtzange nach Walsham, zerlegbar, 21,5 cm



344100FX **Septum Straightening Forceps by Cottle-W**, straight, 23 cm
Septumrichtzange nach Cottle-Walsham, gerade, 23 cm

344100FX	straight / 23 cm	gerade / 23 cm
344201FX	left / 23 cm	links / 23 cm
344202FX	right / 23 cm	rechts / 23 cm



345100FX **Septum Straightening Forceps by Asch**, 22.5 cm
Septumrichtzange nach Asch, 22,5 cm

Rhinology
Rhinologie



360600FX **Nasal Fracture Elevator**, strong pattern, 17 cm
Nasenfraktur Elevatorium, kräftiges Modell, 17 cm



361100FX **Nasal Fracture Elevator by Boies**, 18.5 cm
Nasenfraktur Elevatorium nach Boies, 18,5 cm



361200FX **Nasal Fracture Elevator by Goldman**, 19.5 cm
Nasenfraktur Elevatorium nach Goldman, 19,5 cm



086108FX **Towel Forceps by Backhaus, 8 cm**
Tuchklemme nach Backhaus, 8 cm

086108FX	8 cm	8 cm
086111FX	11 cm	11 cm
086113FX	13 cm	13 cm



222317FX **Nasal Dressing Forceps by Tilley, 17 cm**
Nasentamponzange nach Tilley, 17 cm

Rhinology Rhinologie

The NT-Rhinoplasty Set designed by Prof. G. J. Nolst Trenité includes a number of extremely high quality instruments for functional and cosmetic rhinoplasty procedures. The golden Titanium Nitride coating indicates that these German made precision instruments have been carefully designed to help improve the surgical result by reducing postoperative ecchymosis and oedema.

Das NT-Rhinoplastik-Set, entwickelt von Prof. Dr. G. J. Nolst Trenité, besteht aus sehr hochwertigen Instrumenten, die besonders für die delikaten chirurgischen Arbeiten bei funktionalen und kosmetischen Nasenkorrekturen hilfreich sind. Die NT-Instrumente ergänzen das vorhandene Grundsieb, wobei die goldfarbene Titannitritbeschichtung kennzeichnend für die dauerhafte Qualität dieser Produkte ist. Die Operationsergebnisse lassen sich durch den Einsatz hochwertiger Instrumente optimieren (geringere postoperative Einblutungen und reduzierte Narbenbildung).



308500FX **Micro Osteotome**, with guard, Nolst Trenité pattern, 18 cm, width 2.2 mm
Mikro-Osteotom, mit Schutzdorn, Nolst Trenité Modell, 18 cm, Breite 2,2 mm



308501FX **Micro Osteotome**, with guard, Nolst Trenité pattern, 18 cm, width 3 mm
Mikro-Osteotom, mit Schutzdorn, Nolst Trenité Modell, 18 cm, Breite 3 mm



308499FX **Micro Osteotome**, with guard, Nolst Trenité pattern, 18 cm, width 4 mm
Mikro-Osteotom, mit Schutzdorn, Nolst Trenité Modell, 18 cm, Breite 4 mm



308502FX **Micro Osteotome**, Nolst Trenité pattern, 18 cm, width 2 mm
Mikro-Osteotom, Nolst Trenité Modell, 18 cm, Breite 2 mm



308525FX **Micro Osteotome**, Nolst Trenité pattern, 18 cm, width 2.5 mm
Mikro-Osteotom, Nolst Trenité Modell, 18 cm, Breite 2,5 mm



308503FX **Micro Osteotome**, Nolst Trenité pattern, 18 cm, width 3 mm
Mikro-Osteotom, Nolst Trenité Modell, 18 cm, Breite 3 mm



308504FX **Micro Osteotome**, Nolst Trenité pattern, 18 cm, width 4 mm
Mikro-Osteotom, Nolst Trenité Modell, 18 cm, Breite 4 mm



308506FX **Micro Osteotome**, Nolst Trenité pattern, 18 cm, width 6 mm
Mikro-Osteotom, Nolst Trenité Modell, 18 cm, Breite 6 mm

Rhinology
Rhinologie



308510FX **Hump Osteotome**, Nolst Trenité pattern, 18 cm, width 10 mm
Höcker-Osteotom, Nolst Trenité Modell, 18 cm, Breite 10 mm



308512FX **Hump Osteotome**, Nolst Trenité pattern, 18 cm, width 12 mm
Höcker-Osteotom, Nolst Trenité Modell, 18 cm, Breite 12 mm



308514FX **Hump Osteotome**, Nolst Trenité pattern, 18 cm, width 14 mm
Höcker-Osteotom, Nolst Trenité Modell, 18 cm, Breite 14 mm



308516FX **Hump Osteotome**, Nolst Trenité pattern, 18 cm, width 16 mm
Höcker-Osteotom, Nolst Trenité Modell, 18 cm, Breite 16 mm



308518FX **Hump Osteotome**, Nolst Trenité pattern, 18 cm, width 18 mm
Höcker-Osteotom, Nolst Trenité Modell, 18 cm, Breite 18 mm



308523FX **Raspatory by Lempert-Joseph**, Nolst Trenité pattern, 20 cm
Raspatorium nach Lempert-Joseph, Nolst Trenité Modell, 20 cm



308540FX **Glabella Nasal Rasp by Aufricht**, Nolst Trenité pattern, 20 cm
Glabella Nasenraspel nach Aufricht, Nolst Trenité Modell, 20 cm



308560FX **Nasal Retractor by Aufricht**, Nolst Trenité pattern
Nasenrückenhaken nach Aufricht, Nolst Trenité Modell



330101FX **Nasal Forceps by Blakesley**, Nolst Trenité pattern, WL 11 cm
Nasenzange nach Blakesley, Nolst Trenité Modell, NL 11 cm



325612FX **Tissue Forceps by Adson-Brown**, Nolst Trenité pattern, 12 cm
Pinzette nach Adson-Brown, Nolst Trenité Modell, 12 cm



325712FX **Dressing Forceps by Adson**, Nolst Trenité pattern, 12 cm
Anatomische Pinzette nach Adson, Nolst Trenité Modell, 12 cm



325812FX **Tissue Forceps by Adson**, Nolst Trenité pattern, 12 cm, 1 x 2 teeth
Chirurgische Pinzette nach Adson, Nolst Trenité Modell, 12 cm, 1 x 2 Zähne



177615FX **Rhinoplastic Scissors**, straight, sh/sh, Nolst Trenité pattern, 10 cm
Rhinoplastik Schere, gerade, sp/sp, Nolst Trenité Modell, 10 cm



177715FX **Rhinoplastic Scissors**, curved, sh/sh, Nolst Trenité pattern, 10 cm
Rhinoplastik Schere, gebogen, sp/sp, Nolst Trenité Modell, 10 cm



338610FX **Scissors by Walter**, angled, Nolst Trenité pattern, 10 cm
Schere nach Walter, abgewinkelt, Nolst Trenité Modell, 10 cm



338915FX **Scissors by Kilner**, curved, Nolst Trenité pattern, 14 cm
Schere nach Kilner, gebogen, Nolst Trenité Modell, 14 cm



308551FX **Hook**, 1 prong, Nolst Trenité pattern
Häkchen, einzahnig, Nolst Trenité Modell



308552FX **Hook**, 2 prongs, Nolst Trenité pattern, width 2 mm
Häkchen, zweizahnig, Nolst Trenité Modell, Breite 2 mm



308555FX **Hook**, 2 prongs, Nolst Trenité pattern, width 10 mm
Häkchen, zweizahnig, Nolst Trenité Modell, Breite 10 mm

Numerical Index
Numerischer Index

Kat. Nr.	Seite
Cat. No.	Page
032113FX	26
032116FX	26
032118FX	26
032416FX	27
032419FX	27
040100FX	6
040110FX	6
041101FX	6
041102FX	6
041103FX	6
041401FX	7
041402FX	7
041403FX	7
041601FX	8
041602FX	8
041603FX	8
041701FX	9
041702FX	9
041703FX	9
041801FX	10
041802FX	10
041803FX	10
042001FX	12
042002FX	12
042003FX	12
042004FX	12
042101FX	13
042102FX	13
042103FX	13
042104FX	13
042240FX	14
042255FX	14
042275FX	14
042290FX	14
042340FX	15
042355FX	15
042375FX	15
042390FX	15
042700FX	16
042740FX	16
042755FX	16
042775FX	16
042790FX	16
043101FX	11
043102FX	11
045600FX	27
086108FX	120
086111FX	120
086113FX	120
108101FX	55
108102FX	55
108103FX	55
108104FX	55
108107FX	55
108712FX	105
108812FX	105
109310FX	106
109320FX	106

Kat. Nr.	Seite
Cat. No.	Page
109410FX	106
109420FX	106
109515FX	106
110106FX	28
110107FX	28
110108FX	28
110110FX	28
110112FX	28
110115FX	28
110116FX	29
110118FX	29
110120FX	29
110122FX	29
110125FX	29
112114FX	90
112117FX	90
112214FX	90
112217FX	90
113115FX	107
113213FX	107
118900FX	22
118901FX	22
118904FX	22
130100FX	78
168310FX	89
168410FX	89
168513FX	90
168713FX	90
168813FX	90
176614FX	91
176714FX	91
176814FX	91
176914FX	91
177110FX	92
177112FX	92
177210FX	92
177212FX	92
177312FX	92
177412FX	92
177510FX	97
177511FX	97
177521FX	97
177610FX	94
177612FX	94
177615FX	126
177621FX	94
177710FX	94
177712FX	94
177715FX	126
177721FX	94
177812FX	94
177822FX	94
177912FX	94
177922FX	94
179715FX	92
179718FX	92
179815FX	92
179818FX	92

Kat. Nr.	Seite
Cat. No.	Page
210300FX	36
210600FX	36
211100FX	36
211135FX	36
211203FX	36
211616FX	29
211618FX	29
213100FX	55
214100FX	55
215100FX	56
215200FX	56
215215FX	56
215300FX	56
215310FX	57
215700FX	57
216100FX	57
216200FX	57
216600FX	58
219101FX	58
219102FX	58
220101FX	58
220102FX	59
221100FX	59
221200FX	59
222121FX	33
222216FX	33
222317FX	120
223600FX	33
224100FX	34
226100FX	38
226109FX	38
226111FX	38
226200FX	38
226201FX	38
226202FX	38
226300FX	37
226300FXF	37
226301FX	37
226301FXF	37
226302FX	37
226302FXF	37
226303FX	37
226304FX	37
226400FX	38
226401FX	38
226402FX	38
226901FX	45
226902FX	45
226903FX	45
226904FX	46
226905FX	46
226906FX	47
226907FX	47
226908FX	47
226909FX	48
226910FX	48
226911FX	48
226912FX	49

Kat. Nr.	Seite
Cat. No.	Page
226913FX	49
226914FX	49
226915FX	46
227100FX	42
227101FX	42
227102FX	42
227600FX	39
228100FX	39
228101FX	39
228102FX	39
228601FX	40
228602FX	40
228603FX	40
229101FX	41
229102FX	41
229103FX	41
229104FX	41
230100FX	43
230101FX	43
230102FX	43
230103FX	43
230104FX	43
230200FX	43
230201FX	43
230202FX	43
230203FX	43
230204FX	43
230300FX	43
230301FX	43
230302FX	43
230303FX	43
230400FX	42
231101FX	50
231102FX	50
231601FX	44
231602FX	44
231603FX	44
231701FX	44
231702FX	44
231801FX	44
231802FX	44
232101FX	50
232102FX	50
232103FX	50
232104FX	50
233100FX	51
233200FX	51
233300FX	52
235600FX	52
235700FX	52
250106FX	28
250108FX	28
250110FX	28
250112FX	28
250115FX	28
300101FX	17
300102FX	17
300103FX	17

Numerical Index

Numerischer Index

Kat. Nr. Cat. No.	Seite Page
300104FX	17
300201FX	18
300202FX	18
300203FX	18
300204FX	18
300601FX	19
300603FX	19
300604FX	19
300640FX	19
300655FX	19
300675FX	19
300690FX	19
300740FX	20
300755FX	20
300775FX	20
300790FX	20
300840FX	21
300855FX	21
300875FX	21
300890FX	21
301100FX	102
301200FX	102
302103FX	60
302104FX	60
302105FX	60
302600FX	60
303100FX	81
303900FX	62
304600FX	60
304900FX	60
305100FX	61
305600FX	61
305700FX	61
305900FX	62
306110FX	73
306112FX	73
306114FX	73
306116FX	73
306200FX	74
306404FX	67
306610FX	74
306612FX	74
306614FX	74
306616FX	74
307104FX	63
307107FX	63
307109FX	63
307112FX	63
307206FX	63
307304FX	63
307306FX	63
307307FX	63
307309FX	63
307312FX	63
307402FX	69
307404FX	69
307406FX	69
307408FX	69

Kat. Nr. Cat. No.	Seite Page
307410FX	69
307412FX	69
307422FX	70
307424FX	70
307426FX	70
307428FX	70
307430FX	70
307432FX	70
307502FX	64
307504FX	64
307507FX	64
307509FX	64
307512FX	64
307604FX	65
307606FX	65
307702FX	67
307703FX	67
307704FX	67
307705FX	67
307706FX	67
307707FX	67
307708FX	67
307709FX	67
307710FX	67
307711FX	67
307712FX	67
307804FX	65
307806FX	65
307902FX	71
307903FX	71
307904FX	71
307905FX	71
307906FX	71
307907FX	71
307908FX	71
307909FX	71
307910FX	71
307911FX	71
307912FX	71
307914FX	71
308000FX	72
308001FX	72
308002FX	72
308021FX	72
308022FX	72
308499FX	121
308500FX	121
308501FX	121
308502FX	122
308503FX	122
308504FX	122
308506FX	122
308510FX	123
308512FX	123
308514FX	123
308516FX	123
308518FX	123
308523FX	124

Kat. Nr. Cat. No.	Seite Page
308525FX	122
308540FX	124
308551FX	127
308552FX	127
308555FX	127
308560FX	124
309630FX	75
309645FX	75
309702FX	75
309703FX	75
309704FX	75
309707FX	75
309709FX	75
309712FX	75
310100FX	76
310101FX	76
310102FX	76
310105FX	76
310600FX	65
310605FX	66
310610FX	66
310612FX	66
310614FX	66
310616FX	66
310800FX	68
310801FX	68
310802FX	68
311100FX	116
312100FX	77
312101FX	77
312102FX	77
312600FX	77
312601FX	77
312602FX	77
313100FX	78
313600FX	79
313601FX	79
315100FX	83
315200FX	83
316100FX	83
316200FX	83
316300FX	83
316400FX	84
316500FX	84
316602FX	84
316605FX	84
316607FX	84
316610FX	84
316612FX	84
316700FX	85
317100FX	85
317200FX	85
318100FX	85
319100FX	86
319600FX	86
320100FX	86
320101FX	86
320600FX	86

Kat. Nr. Cat. No.	Seite Page
320700FX	87
322600FX	88
322700FX	88
322900FX	88
324300FX	88
324400FX	89
324401FX	89
324402FX	89
325112FX	102
325212FX	102
325312FX	103
325412FX	103
325512FX	103
325612FX	125
325712FX	125
325812FX	125
326111FX	104
326315FX	104
327115FX	104
328100FX	104
328110FX	105
329103FX	80
329107FX	80
329110FX	80
329111FX	80
329115FX	80
329410FX	81
329430FX	81
329462FX	81
329464FX	81
329465FX	81
329467FX	81
329500FX	80
330101FX	125
332100FX	81
334100FX	82
335100FX	82
335300FX	82
338510FX	98
338610FX	126
338612FX	98
338712FX	99
338812FX	93
338814FX	93
338913FX	93
338915FX	127
339100FX	99
339101FX	99
339102FX	100
339103FX	100
339200FX	100
339300FX	101
339400FX	101
340100FX	53
340600FX	54
340800FX	54
341600FX	53
342100FX	53

Numerical Index
Numerischer Index

Kat. Nr.	Seite
Cat. No.	Page
343100FX	118
344100FX	118
344201FX	118
344202FX	118
345100FX	118
348101FX	117
348102FX	117
348200FX	117
350100FX	117
350700FX	117
352101FX	110
352102FX	110
352103FX	110
352104FX	110
352105FX	110
353100FX	113
353101FX	111
353102FX	111
353103FX	111
353104FX	111
353105FX	111
353106FX	111
353107FX	111
353108FX	111
353200FX	114
353300FX	114
353501FX	111
353502FX	111
353503FX	111
353504FX	111
353505FX	111
353506FX	111
353507FX	111
353508FX	111
353600FX	112
353601FX	112
353602FX	112
353603FX	113
353604FX	113
353620FX	113
353700FX	112
353800FX	112
353900FX	112
354000FX	114
354001FX	114
354100FX	114
354500FX	115
354600FX	115
354700FX	115
357200FX	115
357300FX	115
357401FX	116
357403FX	116
357500FX	116
360100FX	62
360600FX	119
361100FX	119
361200FX	119

Kat. Nr.	Seite
Cat. No.	Page
363600FX	117
365113FX	108
367115FX	108
367117FX	109
368109FX	109
397400FX	23
397500FX	23
397701FX	24
397702FX	24
397705FX	25
397706FX	25
442114FX	95
442118FX	95
442120FX	95
442214FX	96
442218FX	96
442220FX	96
442314FX	95
442318FX	95
442320FX	95
442514FX	96
442518FX	96
442714FX	95
442718FX	95
442720FX	95
442814FX	96
442818FX	96
464100FX	87
464200FX	87
726504FX	32
726506FX	32
726508FX	32
726516FX	32
730116FX	30
730119FX	30
731116FX	30
731119FX	30
732116FX	30
732119FX	30
741116FX	30
741119FX	30
742116FX	30
742119FX	30
750861FX	31
761116FX	31
761119FX	31
762119FX	31
840100FX	34
840101FX	34
840200FX	35
840300FX	35

Kat. Nr.	Seite
Cat. No.	Page

Kat. Nr.	Seite
Cat. No.	Page

Numerical Index
Numerischer Index

Kat. Nr.	Seite
Cat. No.	Page

Kat. Nr.	Seite
Cat. No.	Page

Kat. Nr.	Seite
Cat. No.	Page

Kat. Nr.	Seite
Cat. No.	Page

Author / Description	Page
Adapter	22
Alar Retractor by Converse	88
Alar Retractor by Cottle	86
Alar Retractor by Kilner	89
Atraumatic Forceps by Glanz	104
Bipolar Cable	32
Bipolar Forceps	30, 31
Bone & Cartilage Crusher by Cottle	117
Bone Cutting Forceps by Cottle-Kazanjian	53
Cartilage Forceps by Hinderer	104
Cartilage Insertion Forceps by Cottle	116
Chisel by Converse	72
Chisel by Cottle	63, 64
Chisel by Freer	58, 59
Chisel by Masing	76
Chisel by Peck	67
Choana Hook by Lange	27
Clamp	22
Columella Forceps by Cottle	102
Dissecting Scissors by Metzenbaum	95
Dissecting Scissors by Metzenbaum-Fino	96
Dissecting Scissors by Reynolds	92
Dorsal Scissors by Cottle	100, 101
Dorsal Scissors by Fomon	99, 100
Dressing Forceps by Adson	102, 125
Dressing Forceps by Micro-Adson	103
Dressing Forceps by Semken	105
Ear Dressing Forceps by Gruenwald	27
Ear Dressing Forceps by Troeltsch	26
Elevator	57
Elevator by Cottle	60, 61
Elevator by Freer	56
Elevator by Freer-Joseph	57
Elevator by Masing	61
Elevator by McKenty	60
Elevator by Pennington	61
Elevator by Weiss	56
Fixation Forceps by Graefe	104
Flexible Arm with Holding Rod	22
Glabella Nasal Rasp by Aufricht	113, 115, 124
Gouge by Rubin	74
Gouge by Walter	75
Hook	127
Hook by Cottle	83, 85
Hook by Freer	84
Hump Osteotome	123
Iris Forceps by Graefe	106
Knife Guide/Retractor by Cottle-Neivert	86
Light Carrier	16
Liquid Atomizer	34, 35
Lower Lateral Forceps by Cottle	104
Mallet by Cottle	78
Metal Mallet	79
Micro Osteotome	121, 122
Mini Scalpel Blade	81
Mini-Osteotome	69, 70
Mucosa Knife by Freer	55
Nasal Cotton Applicator	29

Author / Description	Page
Nasal Cutting Forceps by Gruenwald-Henke	40
Nasal Cutting Forceps by Hartmann	41
Nasal Cutting Forceps by Schmeden	39
Nasal Dressing Forceps by Hartmann	33
Nasal Dressing Forceps by Tilley	120
Nasal Dressing Forceps by Westmacott	33, 34
Nasal Forceps	45, 46, 47, 48, 49
Nasal Forceps by Blakesley	43, 44, 125
Nasal Forceps by Blakesley-Wilde	43
Nasal Forceps by Struempel-Voss	42
Nasal Fracture Elevator	119
Nasal Hook by Fomon	85
Nasal Hump Rongeur by Rowland	54
Nasal Knife by Cottle	81
Nasal Rasp	110, 116
Nasal Rasp by Aufricht	115
Nasal Rasp by Cottle	114, 115
Nasal Rasp by Cottle-Masing	113, 114
Nasal Rasp by Fomon	116
Nasal Rasp by Joseph	114
Nasal Rasp by Maltz	111, 112
Nasal Rasp by Miller	113
Nasal Rasp by Parkes	111
Nasal Retractor by Aufricht	23, 88, 124
Nasal Retractor by Walter	87
Nasal Saw by Joseph	117
Nasal Scissors	37, 38
Nasal Scissors by Caplan	54
Nasal Scissors by Heymann	38
Nasal Snare by Krause	36
Nasal Speculum Model Vienna	9
Nasal Speculum by Beckmann	10
Nasal Speculum by Cottle	17, 18, 19
Nasal Speculum by Hartmann	8, 11
Nasal Speculum by Hartmann-Halle	6
Nasal Speculum by Killian	12, 13, 16, 20, 21, 24, 25
Nasal Speculum by Killian-Struycken	14, 15
Nasal Speculum by Killian-Walter	19
Nasal Speculum by Thudichum	7
Nasal Speculum by Tieck-Halle	6
Nasal Spoon Forceps	46, 47, 48
Needle Holder by Crile-Wood	107
Needle Holder by Masing-Cottle	109
Needle Holder by Neivert	108
Needle Holder by Senning	109
Oil Whetstone "Arkansas"	62
Operating Scissors by Mayo	90
Osteotome "Model Würzburg"	68
Osteotome by Cinelli	74
Osteotome by Converse	71
Osteotome by Cottle	63, 65, 66
Osteotome by Neivert	77
Osteotome by Rubin	73
Osteotome by Sheehan	67
Osteotome by Silver	77
Osteotome by Walter	75
Raspatory by Cottle	58
Raspatory by Freer	56

Author / Description	Page
Raspatory by Lempert	55
Raspatory by Lempert-Joseph	124
Retractor by Cottle	85, 88
Retractor by Senn-Miller.	87
Rhinoplastic Knife by Joseph	82
Rhinoplastic Scissors	126
Rubber Bulb.	35
Ruler with mm and inch scale.	117
Scalpel Blades	80
Scalpel Handle	81
Scalpel Handle by Masing	80
Scissors	92, 94
Scissors by Fomon	98, 99
Scissors by Goldman-Fox	90
Scissors by Joseph	91
Scissors by Kilner	93, 127
Scissors by Stevens.	89
Scissors by Walter	98, 126
Septum Forceps by Bruenings.	50
Septum Forceps by Craig	51
Septum Forceps by Jansen	52
Septum Forceps by Luc	50
Septum Gouge by Killian-Claus	59
Septum Knife by Freer	55
Septum Morcelizer by Rubin.	53
Septum Straightening Forceps by Asch.	118
Skin Hook by Frazier	85
Skin Hook by Gillies	84
Spare Bottle.	34
Spare Nylon Facings	79
Suction Elevator by Gorney	62
Suction Tube by Frazier	28, 29
Suture Forceps by Castroviejo	105
Swivel Knife by Ballenger	58
Tenotomy Scissors by Stevens.	97
Tissue Forceps by Adson.	103, 125
Tissue Forceps by Adson-Brown	102, 125
Tissue Forceps by Gillies.	106
Tissue Forceps by Micro-Adson	103
Tissue Forceps by Semken.	105
Towel Forceps by Backhaus	120

Author / Description	Page
----------------------	------

Autor / Beschreibung	Seite
Abziehstein „Arkansas“	62
Adapter	22
Anatomische Pinzette nach Adson	102, 125
Anatomische Pinzette nach Mikro-Adson	103
Anatomische Pinzette nach Semken	105
Atraumatische Pinzette nach Glanz	104
Bipolare Pinzette	30, 31
Bipolares HF Kabel	32
Chirurgische Pinzette nach Adson	103, 125
Chirurgische Pinzette nach Gillies	106
Chirurgische Pinzette nach Mikro-Adson	103
Chirurgische Pinzette nach Semken	105
Chirurgische Schere nach Mayo	90
Choanenhaken nach Lange	27
Columella Pinzette nach Cottle	102
Conchotom nach Grünwald-Henke	40
Conchotom nach Hartmann	41
Conchotom nach Schmeden	39
Doppel-Nasenflügelhaken nach Converse	88
Doppelelevatorium nach Cottle	60, 61
Doppelelevatorium nach Freer	56
Doppelelevatorium nach Freer-Joseph	57
Doppelelevatorium nach Masing	61
Doppelelevatorium nach McKenty	60
Doppelelevatorium nach Pennington	61
Doppelelevatorium nach Weiss	56
Doppelhaken nach Cottle-Neivert	86
Doppelinstrument nach Walter	87
Drahtschlinge	36
Elevatorium	57
Elevatorium nach McKenty	60
Ersatzflasche	34
Fadenpinzette nach Castroviejo	105
Fixierpinzette nach Graefe	104
Flachmeißel nach Freer	58, 59
Flexibler Arm mit Haltestange	22
Flüssigkeitszerstäuber	34, 35
Glabella Nasenraspel nach Aufricht	113, 115, 124
Gummiball	35
Haken nach Cottle	85
Hammer nach Cottle	78
Hauthäkchen nach Frazier	85
Hauthäkchen nach Gillies	84
Hohlmeißel nach Rubin	74
Hohlmeißel nach Walter	75
Häkchen	127
Häkchen nach Cottle	83, 85, 88
Häkchen nach Freer	84
Höcker-Osteotom	123
Irispinzette nach Graefe	106
Knochenfeile nach Cottle-Masing	113, 114
Knochenraspel	110
Knochensplitterzange n. Cottle-Kazanjan	53
Knorpel-/Knochenquetsche nach Cottle	117
Knorpel einlegepinzette nach Cottle	116
Knorpelquetschzange nach Rubin	53
Lichtträger	16
Meißel nach Converse	72

Autor / Beschreibung	Seite
Meißel nach Cottle	63, 64
Meißel nach Masing	76
Meißel nach Peck	67
Messstab mit mm und Zoll Skala	117
Metallhammer	79
Mikro-Osteotom	121, 122
Mini-Osteotom	69, 70
Mini-Skalpellklingen	81
Mukosamesser nach Freer	55
Nadelhalter nach Crile-Wood	107
Nadelhalter nach Masing-Cottle	109
Nadelhalter nach Neivert	108
Nadelhalter nach Senning	109
Nasenflügelhaken nach Cottle	86
Nasenflügelhaken nach Fomon	85
Nasenflügelhaken nach Kilner	89
Nasenfraktur Elevatorium	119
Nasenhaken nach Aufricht	23
Nasenlöffelzange	46, 47, 48
Nasenpinzette nach Cottle	104
Nasenplastikmesser nach Joseph	82
Nasenpolypenschnürer nach Krause	36
Nasenraspel	116
Nasenraspel nach Aufricht	115
Nasenraspel nach Cottle	114, 115
Nasenraspel nach Fomon	116
Nasenraspel nach Joseph	114
Nasenraspel nach Maltz	111, 112
Nasenraspel nach Miller	113
Nasenraspel nach Parkes	111
Nasentrückenhaken nach Aufricht	88, 124
Nasenschere	37, 38
Nasenschere nach Caplan	54
Nasenschere nach Cottle	100, 101
Nasenschere nach Fomon	99, 100
Nasenschere nach Heymann	38
Nasenspekulum Modell Wien	9
Nasenspekulum nach Beckmann	10
Nasenspekulum nach Cottle	17, 18, 19
Nasenspekulum nach Hartmann	8, 11
Nasenspekulum nach Hartmann-Halle	6
Nasenspekulum nach Killian	12, 13, 16, 20, 21, 24, 25
Nasenspekulum nach Killian-Struycken	14, 15
Nasenspekulum nach Killian-Walter	19
Nasenspekulum nach Thudichum	7
Nasenspekulum nach Tieck-Halle	6
Nasensäge nach Joseph	117
Nasentamponzange nach Hartmann	33
Nasentamponzange nach Tilley	120
Nasentamponzange nach Westmacott	33, 34
Nasenwatteträger	29
Nasenzange	45, 46, 47, 48, 49
Nasenzange nach Blakesley	43, 44, 125
Nasenzange nach Blakesley-Wilde	43
Nasenzange nach Rowland	54
Nasenzange nach Struempel-Voss	42
Nylon-Ersatzbacken	79
Ohrpinzette nach Grünwald	27

Autor / Beschreibung	Seite
Ohrpinzette nach Troeltsch	26
Osteotom „Würzburger Modell“	68
Osteotom nach Cinelli	74
Osteotom nach Converse	71
Osteotom nach Cottle	63, 65, 66
Osteotom nach Neivert	77
Osteotom nach Rubin	73
Osteotom nach Sheehan	67
Osteotom nach Silver	77
Osteotom nach Walter	75
Pinzette nach Adson-Brown	102, 125
Präparierschere nach Metzenbaum	95
Präparierschere nach Metzenbaum-Fino	96
Präparierschere nach Reynolds	92
Raspatorium nach Cottle	58
Raspatorium nach Freer	56
Raspatorium nach Lempert	55
Raspatorium nach Lempert-Joseph	124
Rhinoplastik Schere	126
Ritzmesser nach Masing	81
Saugelevatorium nach Gorney	62
Saugkanüle nach Frazier	28
Saugrohr nach Frazier	29
Schere	92, 94
Schere nach Fomon	98, 99
Schere nach Goldman-Fox	90
Schere nach Joseph	91
Schere nach Kilner	93, 127
Schere nach Stevens	89
Schere nach Walter	98, 126
Schwingmesser nach Ballenger	58
Sehnenschere nach Stevens	97
Septummeißel nach Killian-Claus	59
Septummesser nach Cottle	81
Septummesser nach Freer	55
Septumrichtzange nach Asch	118
Septumschere nach Becker	53
Septumzange nach Bruenings	50
Septumzange nach Craig	51
Septumzange nach Jansen	52
Septumzange nach Luc	50
Skalpellgriff	80, 81
Skalpellgriff nach Masing	80
Spannkloben	22
Tuchklemme nach Backhaus	120
Wundhäkchen nach Senn-Miller	87

Autor / Beschreibung	Seite
----------------------	-------

FENTEX *medical* GmbH

take-off GewerbePark 2
D-78579 Neuhausen ob Eck

Tel. +49 (0) 7467 - 949 62 0
Fax +49 (0) 7467 - 949 62 17
info@fentexmedical.com
www.fentexmedical.com

FENTEX *Instruments · Made in Germany*

© FENTEXmedical GmbH · 2024 · Art.-Nr 002FX

