

Precision meets Quality

Sinus Surgery
Nasennebenhöhlen

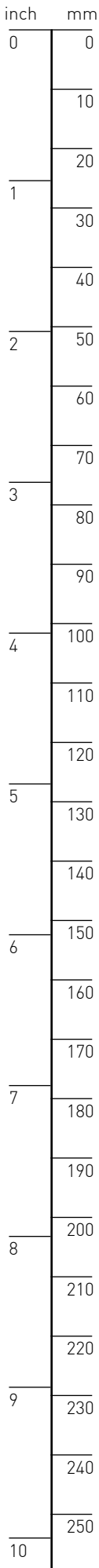

Edition 2024

The content of this catalogue is the literary property of FENTEX medical GmbH. The reproduction, translation or partial utilization of information is not permitted without prior written authorization from FENTEX medical.

All products shown in this catalogue carry a CE mark and are certified for distribution within the appropriate markets. Please note that some international markets have special certification requirements and that restrictions may apply. Information is available from FENTEX medical upon request.

Please refer to the current version of our general terms and conditions as well as the latest price list for further information on product availability and shipment terms.

We continuously strive to improve and update our products, to always meet or excel our customer's expectations and thus reserve the right to make alterations to our products without prior notice.



FENTEXmedical GmbH is certified according to EN ISO 13485 : 2016 + AC : 2016 and directive 93/42/EEC.

Katalogausgabe 2024

Der Inhalt des vorliegenden Kataloges ist das geistige Eigentum der Firma FENTEX medical GmbH. Reproduktionen, Übersetzungen oder auch die teilweise Verwertung von Informationen hieraus sind untersagt bzw. nur nach vorheriger schriftlicher Genehmigung durch die FENTEX GmbH erlaubt.

Bei Verstößen oder Missbrauch behalten wir uns rechtliche Schritte vor. Die Produkte tragen das CE Zeichen und sind damit für dessen Geltungsbereich zugelassen. Für einzelne geografische Märkte kann eine gesonderte Registrierung bzw. Zertifizierung notwendig sein. Informationen dazu werden auf Anfrage mitgeteilt.

Darüber hinaus gelten die Allgemeinen Geschäftsbedingungen der FENTEX Medical GmbH in der jeweils gültigen Fassung, sowie die jeweils aktuelle Preisliste.

Bitte beachten Sie, dass es in Einzelfällen zu leichten Maßabweichungen kommen kann, die aber die grundlegende Funktion der Produkte nicht beeinträchtigen. Modelländerungen vorbehalten.



FENTEXmedical GmbH ist zertifiziert nach EN ISO 13485 : 2016 + AC : 2016 und der Richtlinie 93/42/EWG.

Contact Details

Kontaktinformationen

FENTEXmedical GmbH
take-off GewerbePark 2
D-78579 Neuhausen ob Eck
Germany

Tel. +49 (0) 7467 - 949 62 0
Fax +49 (0) 7467 - 949 62 17

info@fentexmedical.com
www.fentexmedical.com

Sinus Surgery Nasennebenhöhlen

PRECISION MEETS QUALITY

FENTEXmedical GmbH is a medical company specializing in manufacturing and marketing of surgical instruments and endoscopy systems for ENT and Head & Neck surgeons.

Especially in this part of the human body with its anatomical and functional complexity and high aesthetic demands special skills are required. It is our mission not only to meet but to surpass these requirements with our products and services.

PRECISION MEETS QUALITY

FENTEXmedical GmbH ist ein Unternehmen, das sich auf die Entwicklung, Produktion und den Vertrieb chirurgischer Instrumente und Endoskopiesysteme für die Hals- Nasen und Ohrenheilkunde spezialisiert hat.

Gerade in diesem Bereich des menschlichen Körpers sind aufgrund der anatomischen und funktionalen Komplexität sowie der hohen ästhetischen Anforderungen besondere Qualitäten gefordert. Es ist unsere Mission, diese Qualitätsanforderungen mit unseren Produkten und Dienstleistungen nicht nur zu erfüllen sondern zu übertreffen.

Sinus Surgery Nasennebenhöhlen

Precision

We maintain a close cooperation with all of the medical specialists involved in head & neck surgery, including ENT-, Otolaryngologists and Plastic Surgeons. This cooperation allows us to precisely adapt the instrument and match it with the requirements of a particular operational technique. It also ensures that the latest developments are being consistently incorporated into our products. Together with our superior design and finishing we help to ensure your surgical achievements.

Präzision

Wir pflegen die enge Kooperation mit Spezialisten aller im Kopf- und Halsbereich tätigen chirurgischen Disziplinen. Dadurch können wir Ihnen für jede Indikation das passende Instrument bereitstellen und halten unser gesamtes Sortiment auf dem aktuellen Stand der medizinischen Entwicklung. Die Präzision in der Ausführung der Instrumente sichert Ihnen den Operationserfolg.

Customer Orientation

We market our products world wide through highly qualified specialist dealers thus achieving a maximum in local customer-service and -support. Our organisation is open to suggestions from clinical users and demand for custom made devices.

Kundenorientierung

Wir vertreiben unsere Produkte weltweit durch ein fachlich versiertes Händlernetz und erreichen dadurch ein Maximum in der Kundenbetreuung vor Ort. Darüber hinaus sind wir auch jederzeit ansprechbar im Hinblick auf die Sonderwünsche unserer Kunden.



728500FX **Hi-View Telescope**, autoclavable, 0°, WL 110 mm, Ø 2.7 mm
Hi-View Optik, autoklavierbar, 0°, NL 110 mm, Ø 2,7 mm

728500FX	autoclavable / 0°, WL 110 mm, Ø 2.7 mm	autoklavierbar / 0°, NL 110 mm, Ø 2,7 mm
728530FX	autoclavable / 30°, WL 110 mm, Ø 2.7 mm	autoklavierbar / 30°, NL 110 mm, Ø 2,7 mm
728570FX	autoclavable / 70°, WL 110 mm, Ø 2.7 mm	autoklavierbar / 70°, NL 110 mm, Ø 2,7 mm



728200FX **Hi-View Telescope**, autoclavable, 0°, WL 140 mm, Ø 2.7 mm
Hi-View Optik, autoklavierbar, 0°, NL 140 mm, Ø 2,7 mm

728200FX	autoclavable / 0°, WL 140 mm, Ø 2.7 mm	autoklavierbar / 0°, NL 140 mm, Ø 2,7 mm
728230FX	autoclavable / 30°, WL 140 mm, Ø 2.7 mm	autoklavierbar / 30°, NL 140 mm, Ø 2,7 mm
728270FX	autoclavable / 70°, WL 140 mm, Ø 2.7 mm	autoklavierbar / 70°, NL 140 mm, Ø 2,7 mm



728100FX **Hi-View Telescope**, autoclavable, 0°, WL 195 mm, Ø 2.7 mm
Hi-View Optik, autoklavierbar, 0°, NL 195 mm, Ø 2,7 mm

728100FX	autoclavable / 0°, WL 195 mm, Ø 2.7 mm	autoklavierbar / 0°, NL 195 mm, Ø 2,7 mm
728130FX	autoclavable / 30°, WL 195 mm, Ø 2.7 mm	autoklavierbar / 30°, NL 195 mm, Ø 2,7 mm
728170FX	autoclavable / 70°, WL 195 mm, Ø 2.7 mm	autoklavierbar / 70°, NL 195 mm, Ø 2,7 mm



730100FX **Hi-View Telescope**, autoclavable, 0°, WL 150 mm, Ø 3 mm
Hi-View Optik, autoklavierbar, 0°, NL 150 mm, Ø 3 mm

730100FX	autoclavable / 0°, WL 150 mm, Ø 3 mm	autoklavierbar / 0°, NL 150 mm, Ø 3 mm
730130FX	autoclavable / 30°, WL 150 mm, Ø 3 mm	autoklavierbar / 30°, NL 150 mm, Ø 3 mm
730145FX	autoclavable / 45°, WL 150 mm, Ø 3 mm	autoklavierbar / 45°, NL 150 mm, Ø 3 mm



750100FX **Hi-View Telescope**, autoclavable, 0°, WL 185 mm, Ø 4 mm
Hi-View Optik, autoklavierbar, 0°, NL 185 mm, Ø 4 mm

750100FX	autoclavable / 0°, WL 185 mm, Ø 4 mm	autoklavierbar / 0°, NL 185 mm, Ø 4 mm
750130FX	autoclavable / 30°, WL 185 mm, Ø 4 mm	autoklavierbar / 30°, NL 185 mm, Ø 4 mm
750145FX	autoclavable / 45°, WL 185 mm, Ø 4 mm	autoklavierbar / 45°, NL 185 mm, Ø 4 mm
750170FX	autoclavable / 70°, WL 185 mm, Ø 4 mm	autoklavierbar / 70°, NL 185 mm, Ø 4 mm



741200FX **Protection Tube**, for Telescopes
Schutzhülse, für Optiken



863100FX



863110FX



863101FX

863100FX **Antifog solution „ULTRA STOP“**, pipette bottle, 25 ml
Antibeslagmittel „ULTRA STOP“, Pipettenflasche, 25 ml

863110FX **Antifog solution „ULTRA STOP“**, spray bottle, 15 ml
Antibeslagmittel „ULTRA STOP“, Sprühflasche, 15 ml

863101FX **Antifog solution „ULTRA STOP“**, injection vial, sterile, 30 ml
Antibeslagmittel „ULTRA STOP“, Durchstechflasche, steril, 30 ml

Sinus Surgery
Nasennebenhöhlen



418500FX

418500FX **Sinuscopy Trocar**, beak-shaped distal tip, for 4 mm scopes, Ø 5 mm, length of cannula 8.5 cm
Sinuskopie-Trokar, Ende schnabelförmig, für 4 mm Optiken, Ø 5 mm, Länge Trokarhülse 8,5 cm



418600FX

418600FX **Sinuscopy Trocar**, oblique distal tip, for 4 mm scopes, Ø 5 mm, length of cannula 8.5 cm
Sinuskopie-Trokar, Ende schräg, für 4 mm Optiken, Ø 5 mm, Länge Trokarhülse 8,5 cm

418600FX oblique distal tip, for 4 mm scopes / Ø 5 mm, length of cannula 8.5 cm
 Ende schräg, für 4 mm Optiken / Ø 5 mm, Länge Trokarhülse 8,5 cm

418603FX oblique distal tip, for 2.7 mm scopes / Ø 3.3 mm, length of cannula 7.5 cm
 Ende schräg, für 2,7 mm Optiken / Ø 3,3 mm, Länge Trokarhülse 7,5 cm

418604FX oblique distal tip, for 3 mm scopes / Ø 4 mm, length of cannula 7.5 cm
 Ende schräg, für 3 mm Optiken / Ø 4 mm, Länge Trokarhülse 7,5 cm



049415FX **Antrum Trocar Needle by Lichtwitz**, WL 10 cm, Ø 1.5 mm
Kieferhöhlenpunktionsnadel n. Lichtwitz, NL 10 cm, Ø 1,5 mm

049415FX WL 10 cm, Ø 1.5 mm NL 10 cm, Ø 1,5 mm

049418FX WL 10 cm, Ø 1.8 mm NL 10 cm, Ø 1,8 mm

049420FX WL 10 cm, Ø 2 mm NL 10 cm, Ø 2 mm



032416FX **Ear Dressing Forceps by Jansen**, bayonet-shaped, 16 cm
Ohrpinzette nach Jansen, bajonettförmig, 16 cm



049702FX **Antrum Cannula by Van Eicken**, long curved, Luer-Lock, 15 cm, Ø 2.5 mm
Spülröhrchen nach Van Eicken, lang gebogen, Luer-Lock, 15 cm, Ø 2,5 mm

049702FX	long curved, Luer-Lock / 15 cm, Ø 2.5 mm	lang gebogen, Luer-Lock / 15 cm, Ø 2,5 mm
049703FX	long curved, Luer-Lock / 15 cm, Ø 3 mm	lang gebogen, Luer-Lock / 15 cm, Ø 3 mm
049704FX	long curved, Luer-Lock / 15 cm, Ø 4 mm	lang gebogen, Luer-Lock / 15 cm, Ø 4 mm



049712FX **Antrum Cannula by Van Eicken**, short curved, Luer-Lock, 15 cm, Ø 2.5 mm
Spülröhrchen nach Van Eicken, kurz gebogen, Luer-Lock, 15 cm, Ø 2,5 mm

049712FX	short curved, Luer-Lock / 15 cm, Ø 2.5 mm	kurz gebogen, Luer-Lock / 15 cm, Ø 2,5 mm
049713FX	short curved, Luer-Lock / 15 cm, Ø 3 mm	kurz gebogen, Luer-Lock / 15 cm, Ø 3 mm
049714FX	short curved, Luer-Lock / 15 cm, Ø 4 mm	kurz gebogen, Luer-Lock / 15 cm, Ø 4 mm

Sinus Surgery
Nasennebenhöhlen



049802FX **Antrum Cannula by Van Eicken**, long curved, Luer-Lock, malleable, 15 cm, Ø 2.5 mm
Spülröhrchen nach Van Eicken, lang gebogen, Luer-Lock, biegsam, 15 cm, Ø 2,5 mm

049802FX	long curved, Luer-Lock, malleable / 15 cm, Ø 2.5 mm	lang gebogen, Luer-Lock, biegsam / 15 cm, Ø 2,5 mm
049803FX	long curved, Luer-Lock, malleable / 15 cm, Ø 3 mm	lang gebogen, Luer-Lock, biegsam / 15 cm, Ø 3 mm
049804FX	long curved, Luer-Lock, malleable / 15 cm, Ø 4 mm	lang gebogen, Luer-Lock, biegsam / 15 cm, Ø 4 mm

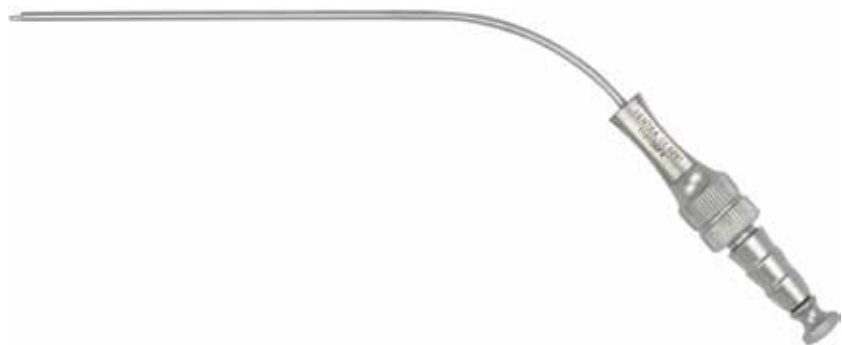

110106FX **Suction Tube by Frazier**, straight tip, with cut-off hole, WL 10 cm, 6 Fr.
Saugrohr nach Frazier, gerades Ende, mit Unterbrecherloch, NL 10 cm, 6 Charr.

110106FX	straight tip, with cut-off hole / WL 10 cm, 6 Fr.	gerades Ende, mit Unterbrecherloch / NL 10 cm, 6 Charr.
110107FX	straight tip, with cut-off hole / WL 10 cm, 7 Fr.	gerades Ende, mit Unterbrecherloch / NL 10 cm, 7 Charr.
110108FX	straight tip, with cut-off hole / WL 10 cm, 8 Fr.	gerades Ende, mit Unterbrecherloch / NL 10 cm, 8 Charr.
110110FX	straight tip, with cut-off hole / WL 10 cm, 10 Fr.	gerades Ende, mit Unterbrecherloch / NL 10 cm, 10 Charr.
110112FX	straight tip, with cut-off hole / WL 10 cm, 12 Fr.	gerades Ende, mit Unterbrecherloch / NL 10 cm, 12 Charr.
110115FX	straight tip, with cut-off hole / WL 10 cm, 15 Fr.	gerades Ende, mit Unterbrecherloch / NL 10 cm, 15 Charr.



110116FX **Suction Tube by Frazier**, ball point tip, with cut-off hole, WL 10 cm, 6 Fr.
Saugrohr nach Frazier, olivenförmiges Ende, mit Unterbrecherloch, NL 10 cm, 6 Charr.

110116FX	ball point tip, with cut-off hole / WL 10 cm, 6 Fr.	olivenförmiges Ende, mit Unterbrecherloch / NL 10 cm, 6 Charr.
110118FX	ball point tip, with cut-off hole / WL 10 cm, 8 Fr.	olivenförmiges Ende, mit Unterbrecherloch / NL 10 cm, 8 Charr.
110120FX	ball point tip, with cut-off hole / WL 10 cm, 10 Fr.	olivenförmiges Ende, mit Unterbrecherloch / NL 10 cm, 10 Charr.
110122FX	ball point tip, with cut-off hole / WL 10 cm, 12 Fr.	olivenförmiges Ende, mit Unterbrecherloch / NL 10 cm, 12 Charr.
110125FX	ball point tip, with cut-off hole / WL 10 cm, 15 Fr.	olivenförmiges Ende, mit Unterbrecherloch / NL 10 cm, 15 Charr.



111106FX **Suction Tube by Frazier**, with graduation, with cut-off hole, WL 10 cm, 6 Fr.
Saugrohr nach Frazier, mit Graduierung, mit Unterbrecherloch, NL 10 cm, 6 Charr.

111106FX	with graduation, with cut-off hole / WL 10 cm, 6 Fr.	mit Graduierung, mit Unterbrecherloch / NL 10 cm, 6 Charr.
111107FX	with graduation, with cut-off hole / WL 10 cm, 7 Fr.	mit Graduierung, mit Unterbrecherloch / NL 10 cm, 7 Charr.
111108FX	with graduation, with cut-off hole / WL 10 cm, 8 Fr.	mit Graduierung, mit Unterbrecherloch / NL 10 cm, 8 Charr.
111109FX	with graduation, with cut-off hole / WL 10 cm, 9 Fr.	mit Graduierung, mit Unterbrecherloch / NL 10 cm, 9 Charr.
111110FX	with graduation, with cut-off hole / WL 10 cm, 10 Fr.	mit Graduierung, mit Unterbrecherloch / NL 10 cm, 10 Charr.
111112FX	with graduation, with cut-off hole / WL 10 cm, 12 Fr.	mit Graduierung, mit Unterbrecherloch / NL 10 cm, 12 Charr.
111115FX	with graduation, with cut-off hole / WL 10 cm, 15 Fr.	mit Graduierung, mit Unterbrecherloch / NL 10 cm, 15 Charr.

Sinus Surgery
Nasennebenhöhlen

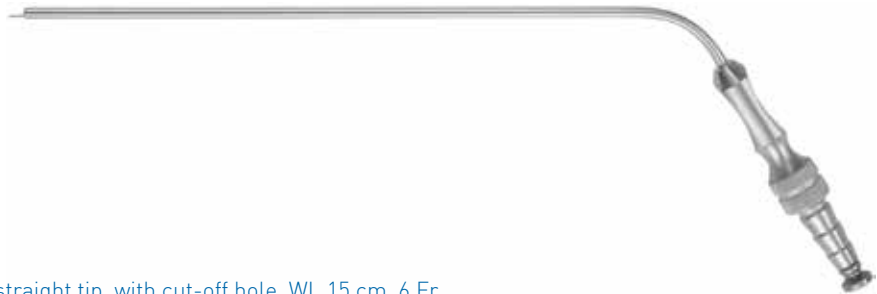

250106FX **Suction Tube by Frazier**, straight tip, with cut-off hole, WL 15 cm, 6 Fr.
Saugkanüle nach Frazier, gerades Ende, mit Unterbrecherloch, NL 15 cm, 6 Charr.

250106FX	straight tip, with cut-off hole / WL 15 cm, 6 Fr.	gerades Ende, mit Unterbrecherloch / NL 15 cm, 6 Charr.
250108FX	straight tip, with cut-off hole / WL 15 cm, 8 Fr.	gerades Ende, mit Unterbrecherloch / NL 15 cm, 8 Charr.
250110FX	straight tip, with cut-off hole / WL 15 cm, 10 Fr.	gerades Ende, mit Unterbrecherloch / NL 15 cm, 10 Charr.
250112FX	straight tip, with cut-off hole / WL 15 cm, 12 Fr.	gerades Ende, mit Unterbrecherloch / NL 15 cm, 12 Charr.
250115FX	straight tip, with cut-off hole / WL 15 cm, 15 Fr.	gerades Ende, mit Unterbrecherloch / NL 15 cm, 15 Charr.



111710FX **Suction Tube by Kahn-Frazier**, slightly curved, malleable shaft, WL 15 cm, 10 Fr.
Saugrohr nach Kahn-Frazier, leicht gebogen, biegsamer Schaft, NL 15 cm, 10 Charr.

111810FX **Suction Tube by Kahn-Frazier**, strongly curved, malleable shaft, WL 15 cm, 10 Fr.
Saugrohr nach Kahn-Frazier, stark gebogen, biegsamer Schaft, NL 15 cm, 10 Charr.

Sinus Surgery
Nasennebenhöhlen



250220FX **Suction Tube by Frank-Pasquini**, tip curved upwards, ball end, WL 13 cm, Ø 3 mm
Saugrohr nach Frank-Pasquini, Spitze aufwärts gebogen, kugelförmiges E, NL 13 cm, Ø 3 mm



250221FX **Suction Tube by Frank-Pasquini**, tip curved downwards, ball end, WL 13 cm, Ø 3 mm
Saugrohr nach Frank-Pasquini, Spitze abwärts gebogen, kugelförmiges En, NL 13 cm, Ø 3 mm

Sinus Surgery
Nasennebenhöhlen



730116FX **Bipolar Forceps**, straight, with guiding pin, 16 cm, tip 0.5 mm
Bipolare Pinzette, gerade, mit Führungsstift, 16 cm, Spitze 0,5 mm

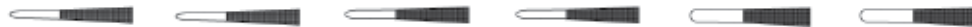

730116FX **730119FX** **731116FX** **731119FX** **732116FX** **732119FX**

730116FX	straight, with guiding pin / 16 cm, tip 0.5 mm	gerade, mit Führungsstift / 16 cm, Spitze 0,5 mm
730119FX	straight, with guiding pin / 19.5 cm, tip 0.5 mm	gerade, mit Führungsstift / 19,5 cm, Spitze 0,5 mm
731116FX	straight, with guiding pin / 16 cm, tip 1 mm	gerade, mit Führungsstift / 16 cm, Spitze 1 mm
731119FX	straight, with guiding pin / 19.5 cm, tip 1 mm	gerade, mit Führungsstift / 19,5 cm, Spitze 1 mm
732116FX	straight, with guiding pin / 16 cm, tip 2 mm	gerade, mit Führungsstift / 16 cm, Spitze 2 mm
732119FX	straight, with guiding pin / 19.5 cm, tip 2 mm	gerade, mit Führungsstift / 19,5 cm, Spitze 2 mm



741116FX **Bipolar Forceps**, angled, with guiding pin, 16 cm, tip 1 mm
Bipolare Pinzette, abgewinkelt, mit Führungsstift, 16 cm, Spitze 1 mm



741116FX **741119FX** **742116FX** **742119FX**

741116FX	angled, with guiding pin / 16 cm, tip 1 mm	abgewinkelt, mit Führungsstift / 16 cm, Spitze 1 mm
741119FX	angled, with guiding pin / 19.5 cm, tip 1 mm	abgewinkelt, mit Führungsstift / 19,5 cm, Spitze 1 mm
742116FX	angled, with guiding pin / 16 cm, tip 2 mm	abgewinkelt, mit Führungsstift / 16 cm, Spitze 2 mm
742119FX	angled, with guiding pin / 19.5 cm, tip 2 mm	abgewinkelt, mit Führungsstift / 19,5 cm, Spitze 2 mm



761116FX **Bipolar Forceps**, bayonet, with guiding pin, 16.5 cm, straight tip 1 mm
Bipolare Pinzette, bajonett, mit Führungsstift, 16,5 cm, gerade Spitze 1 mm



761116FX

761119FX

762119FX

761116FX	bayonet, with guiding pin / 16.5 cm, straight tip 1 mm	bajonett, mit Führungsstift / 16,5 cm, gerade Spitze 1 mm
761119FX	bayonet, with guiding pin / 19 cm, straight tip 1 mm	bajonett, mit Führungsstift / 19 cm, gerade Spitze 1 mm
762119FX	bayonet, with guiding pin / 19 cm, straight tip 2 mm	bajonett, mit Führungsstift / 19 cm, gerade Spitze 2 mm



750861FX **Bipolar Forceps**, angular, with suction, 19 cm, tip 2 mm
Bipolare Pinzette, kniegebogen, mit Saugung, 19 cm, Spitze 2 mm

Sinus Surgery
Nasennebenhöhlen



726504FX **Bipolar Cable**, for ERBE, Storz, Wolf units, 4.5 m
Bipolares HF Kabel, für ERBE, Storz, Wolf Generatoren, 4,5 m



726506FX **Bipolar Cable**, for US Standard + ERBE ICC units, 4.5 m
Bipolares HF Kabel, für US Standard + ERBE ICC Generatoren, 4,5 m



726508FX **Bipolar Cable**, for Martin, Berchtold, Aesculap units, 4.5 m
Bipolares HF Kabel, für Martin, Berchtold, Aesculap Gen., 4,5 m



726516FX **Bipolar Cable**, for Valleylab, Lamidey, EMC, Bowa units, 4.5 m
Bipolares HF Kabel, für Valleylab, Lamidey, EMC, Bowa Gen., 4,5 m



201200FX **Septum Needle**, angled, Luer-Lock, WL 10.5 cm, Ø 0.8 mm
Septumkanüle, kniegebogen, Luer-Lock, NL 10,5 cm, Ø 0.8 mm

Sinus Surgery
Nasennebenhöhlen



215100FX **Elevator by Freer**, double-ended, semi-sharp / blunt, 19 cm
Doppelelevatorium nach Freer, halbscharf / stumpf, 19 cm



215200FX **Elevator by Freer**, double-ended, sharp / blunt, 18 cm
Doppelelevatorium nach Freer, scharf / stumpf, 18 cm



215215FX **Elevator by Weiss**, double-ended, blunt / blunt
Doppelelevatorium nach Weiss, stumpf / stumpf



305100FX **Elevator by Masing**, double-ended, sharp / blunt, graduated, 21.5 cm
Doppelelevatorium nach Masing, scharf / stumpf, graduiert, 21,5 cm



305900FX **Suction Elevator by Gorney**, with Mandrin, 21.5 cm
Saugelevatorium nach Gorney, mit Mandrin, 21,5 cm



360100FX

360100FX **Suction Elevator by Guillen**, straight tip, 20 cm
Saugelevatorium nach Guillen, Spitze gerade, 20 cm



418719FX **Maxillary Sinus Seeker**, double-ended, ball ends, 19 cm, Ø 1.2 mm and 2 mm
Kieferhöhlensonde, doppelendig, kugelförmige Enden, 19 cm, Ø 1,2 mm und 2 mm



418825FX **Frontal Sinus Seeker by Castelnovo**, double-ended, curved, 21 cm
Stirnhöhlensonde nach Castelnovo, doppelendig, gebogen, 21 cm

Sinus Surgery
Nasennebenhöhlen



418826FX **Frontal Sinus Seeker by Kuhn**, double-ended, both sides curved 90°, 19 cm, Fig. 2
Stirnhöhle­sonde nach Kuhn, doppelendig, beide Seiten 90° gebogen, 19 cm, Fig. 2



407125FX **Frontal Sinus Bougie by Ritter-Halle**, 16 cm, Ø 2,5 mm
Stirnhöhle­bougie nach Ritter-Halle, 16 cm, Ø 2,5 mm

407125FX	16 cm, Ø 2,5 mm	16 cm, Ø 2,5 mm
407130FX	16 cm, Ø 3 mm	16 cm, Ø 3 mm
407140FX	16 cm, Ø 4 mm	16 cm, Ø 4 mm
407150FX	16 cm, Ø 5 mm	16 cm, Ø 5 mm



418210FX **Frontal Sinus Rasp by Wigand**, strong pattern, Ø 3 mm
Stirnhöhlenraspel nach Wigand, kräftiges Modell, Ø 3 mm

418211FX **Frontal Sinus Rasp by Wigand**, slender pattern, Ø 2.5 mm
Stirnhöhlenraspel nach Wigand, schlankes Modell, Ø 2,5 mm



408600FX **Antrum Rasp by Watson-Williams**, slightly curved, blunt, 23 cm
Kieferhöhlenraspel nach Watson-Williams, leicht gebogen, stumpf, 23 cm

Sinus Surgery
Nasennebenhöhlen



411100FX **Chisel by West**, 18 cm, width 4 mm
Flachmeißel nach West, 18 cm, Breite 4 mm



411200FX **Gouge by West**, 18 cm, width 4 mm
Hohlmeißel nach West, 18 cm, Breite 4 mm



418100FX **Antrum Elevator by Sewall**, 19.5 cm
Kieferhöhlen-Elevatorium nach Sewall, 19,5 cm



418101FX **Antrum Curette**, oval, 19 cm, size 1
Antrumlöffel, oval, 19 cm, Fig. 1

418101FX	oval / 19 cm, size 1	oval / 19 cm, Fig. 1
418102FX	oval / 19 cm, size 2	oval / 19 cm, Fig. 2
418103FX	oval / 19 cm, size 3	oval / 19 cm, Fig. 3



418201FX **Antrum Curette**, round, small, 19 cm
Antrumlöffel, rund, klein, 19 cm



418202FX **Antrum Curette**, oblong, small, 19 cm
Antrumlöffel, längsoval, klein, 19 cm



418203FX **Antrum Curette**, oblong, large, 19 cm
Antrumlöffel, längsoval, groß, 19 cm

Sinus Surgery
Nasennebenhöhlen



418204FX

418204FX **Frontal Sinus Curette**, 55° curved, oblong, 19 cm
Stirnhöhlenlöffel, 55° gebogen, längsoval, 19 cm



418205FX

418205FX **Frontal Sinus Curette**, 90° curved, oblong, 19 cm
Stirnhöhlenlöffel, 90° gebogen, längsoval, 19 cm



404100FX **Antrum Curette by Faulkner**, double-ended, 21 cm
Kieferhöhlenkürette nach Faulkner, doppelendig, 21 cm



406101FX **Antrum Curette by Halle**, malleable, 21 cm, size 1
Kieferhöhlenlöffel nach Halle, biegsam, 21 cm, Fig. 1

406101FX	malleable / 21 cm, size 1	biegsam / 21 cm, Fig. 1
406102FX	malleable / 21 cm, size 2	biegsam / 21 cm, Fig. 2
406103FX	malleable / 21 cm, size 3	biegsam / 21 cm, Fig. 3



418303FX **Antrum Curette**, small, forward cutting, 19 cm
Antrum-Kürette, klein, vorwärts schneidend, 19 cm



418304FX **Antrum Curette**, small, backward cutting, 19 cm
Antrum-Kürette, klein, rückwärts schneidend, 19 cm

Sinus Surgery
Nasennebenhöhlen



403101FX **Antrum Curette by Coakley**, 18 cm, size 1
Kieferhöhlenkürette nach Coakley, 18 cm, Fig. 1



403102FX **Antrum Curette by Coakley**, 18 cm, size 2
Kieferhöhlenkürette nach Coakley, 18 cm, Fig. 2



403103FX **Antrum Curette by Coakley**, 18 cm, size 3
Kieferhöhlenkürette nach Coakley, 18 cm, Fig. 3



403104FX **Antrum Curette by Coakley**, 18 cm, size 4
Kieferhöhlenkürette nach Coakley, 18 cm, Fig. 4



403105FX **Antrum Curette by Coakley**, 18 cm, size 5
Kieferhöhlenkürette nach Coakley, 18 cm, Fig. 5



403106FX



403106FX **Antrum Curette by Coakley**, 18 cm, size 6
Kieferhöhlenkürette nach Coakley, 18 cm, Fig. 6



418401FX **Sickle Knife**, pointed, 19 cm
Sichelmesser, spitz, 19 cm

418401FX	pointed / 19 cm	spitz / 19 cm
418402FX	round / 19 cm	abgerundet / 19 cm
418403FX	pointed, curved left / 19 cm	spitz, links gebogen / 19 cm
418404FX	pointed, curved right / 19 cm	spitz, rechts gebogen / 19 cm



153700FX **Sickle Knife by Plester**, curved, 16.5 cm
Sichelmesser nach Plester, gebogen, 16,5 cm



226300FX **Nasal Scissors**, straight, serrated, WL 13 cm
Nasenschere, gerade, gezahnt, NL 13 cm

226300FX straight, serrated / WL 13 cm
gerade, gezahnt / NL 13 cm

226300FXF straight, serrated / WL 13 cm, with flush connector
gerade, gezahnt / NL 13 cm, mit Spülanschluss

226301FX curved left, serrated / WL 13 cm
links gebogen, gezahnt / NL 13 cm

226301FXF curved left, serrated / WL 13 cm, with flush connector
links gebogen, gezahnt / NL 13 cm, mit Spülanschluss

226302FX curved right, serrated / WL 13 cm
rechts gebogen, gezahnt / NL 13 cm

226302FXF curved right, serrated / WL 13 cm, with flush connector
rechts gebogen, gezahnt / NL 13 cm, mit Spülanschluss

226303FX curved up, serrated / WL 13 cm
aufwärts gebogen, gezahnt / NL 13 cm

226304FX curved down, serrated / WL 13 cm
abwärts gebogen, gezahnt / NL 13 cm



226400FX **Nasal Scissors**, straight, smooth, WL 11.5 cm
Nasenschere, gerade, glatt, NL 11,5 cm

226400FX	straight, smooth / WL 11.5 cm	gerade, glatt / NL 11,5 cm
226401FX	curved left, smooth / WL 11.5 cm	links gebogen, glatt / NL 11,5 cm
226402FX	curved right, smooth / WL 11.5 cm	rechts gebogen, glatt / NL 11,5 cm



226100FX **Nasal Scissors by Heymann**, standard, smooth blades, WL 9.5 cm
Nasenschere nach Heymann, Standard, glatte Schneiden, NL 9,5 cm

226100FX	standard, smooth blades / WL 9.5 cm	Standard, glatte Schneiden / NL 9,5 cm
226109FX	small, smooth blades / WL 9 cm	klein, glatte Schneiden / NL 9 cm
226111FX	large, smooth blades / WL 11 cm	groß, glatte Schneiden / NL 11 cm
226200FX	standard, serrated blades / WL 9.5 cm	Standard, gezahnte Schneiden / NL 9,5 cm
226201FX	small, curved left, smooth blades / WL 9.5 cm	klein, links gebogen, glatte Schneiden / NL 9,5 cm
226202FX	small, curved right, smooth blades / WL 9.5 cm	klein, rechts gebogen, glatte Schneiden / NL 9,5 cm

Sinus Surgery
Nasennebenhöhlen



- 412502FX** **Bone Punch**, through-cutting, with hooked jaw, WL 18 cm, width 2 mm
Knochenstanze, durchschneidend, mit Hakenmaul, NL 18 cm, Schnittbreite 2 mm
- 412503FX** **Bone Punch**, through-cutting, with hooked jaw, WL 15 cm, width 3 mm
Knochenstanze, durchschneidend, mit Hakenmaul, NL 15 cm, Schnittbreite 3 mm



413002FX

413002FX **Sphenoid Punch by FS-Kerrison, 90° upbiting, detachable, WL 18 cm, width 2 mm**
Knochenstanze nach FS-Kerrison, 90° nach oben schneidend, zerlegbar, NL 18 cm, Schnittbreite 2 mm

413001FX 90° upbiting, detachable / WL 18 cm, width 1 mm
 90° nach oben schneidend, zerlegbar / NL 18 cm, Schnittbreite 1 mm

413002FX 90° upbiting, detachable / WL 18 cm, width 2 mm
 90° nach oben schneidend, zerlegbar / NL 18 cm, Schnittbreite 2 mm

413003FX 90° upbiting, detachable / WL 18 cm, width 3 mm
 90° nach oben schneidend, zerlegbar / NL 18 cm, Schnittbreite 3 mm

413004FX 90° upbiting, detachable / WL 18 cm, width 4 mm
 90° nach oben schneidend, zerlegbar / NL 18 cm, Schnittbreite 4 mm

413021FX 40° upbiting, detachable / WL 18 cm, width 1 mm
 40° nach oben schneidend, zerlegbar / NL 18 cm, Schnittbreite 1 mm

413022FX 40° upbiting, detachable / WL 18 cm, width 2 mm
 40° nach oben schneidend, zerlegbar / NL 18 cm, Schnittbreite 2 mm

413023FX 40° upbiting, detachable / WL 18 cm, width 3 mm
 40° nach oben schneidend, zerlegbar / NL 18 cm, Schnittbreite 3 mm

413024FX 40° upbiting, detachable / WL 18 cm, width 4 mm
 40° nach oben schneidend, zerlegbar / NL 18 cm, Schnittbreite 4 mm

413402FX 90° downbiting, detachable / WL 18 cm, width 2 mm
 90° nach unten schneidend, zerlegbar / NL 18 cm, Schnittbreite 2 mm

413403FX 90° downbiting, detachable / WL 18 cm, width 3 mm
 90° nach unten schneidend, zerlegbar / NL 18 cm, Schnittbreite 3 mm

413404FX 90° downbiting, detachable / WL 18 cm, width 4 mm
 90° nach unten schneidend, zerlegbar / NL 18 cm, Schnittbreite 4 mm

Sinus Surgery
Nasennebenhöhlen



412101FX **Sphenoid Punch by Hajek-Kofler**, 90° upbiting, WL 14 cm, width 4 mm
Knochenstanze nach Hajek-Kofler, 90° nach oben schneidend, NL 14 cm, Schnittbreite 4 mm

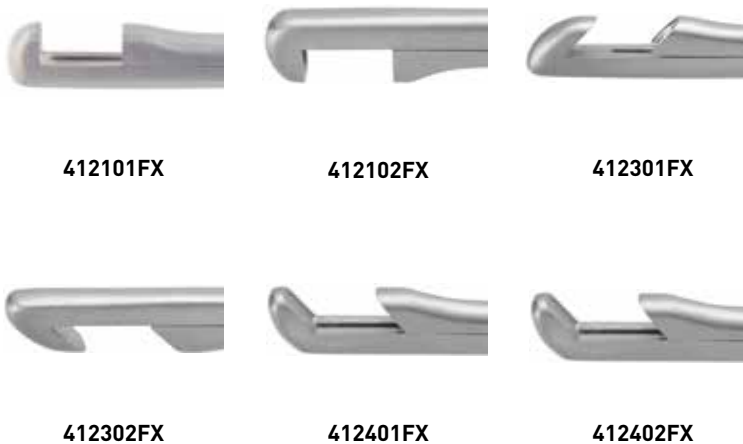

412101FX	90° upbiting / WL 14 cm, width 4 mm 90° nach oben schneidend / NL 14 cm, Schnittbreite 4 mm
412102FX	90° downbiting cutting / WL 14 cm, width 4 mm 90° nach unten schneidend / NL 14 cm, Schnittbreite 4 mm
412301FX	40° upbiting backward cutting / WL 14 cm, width 4 mm 40° nach oben rückwärts schneidend / NL 14 cm, Schnittbreite 4 mm
412302FX	40° downbiting backward cutting / WL 14 cm, width 4 mm 40° nach unten rückwärts schneidend / NL 14 cm, Schnittbreite 4 mm
412401FX	40° upbiting forward cutting / WL 14 cm, width 4 mm 40° nach oben vorwärts schneidend / NL 14 cm, Schnittbreite 4 mm
412402FX	40° upbiting forward cutting / WL 14 cm, width 2 mm 40° nach oben vorwärts schneidend / NL 14 cm, Schnittbreite 2 mm



412600FX

412600FX **Antrum Punch by Beyer**, 90° upbiting, WL 9 cm, width 2 mm
Kieferhöhlenstanze nach Beyer, 90° nach oben schneidend, NL 9 cm, Schnittbreite 2 mm

412601FX **Antrum Punch by Beyer**, 90° upbiting, WL 9 cm, width 1 mm
Kieferhöhlenstanze nach Beyer, 90° nach oben schneidend, NL 9 cm, Schnittbreite 1 mm



413100FX

413100FX **Sphenoid Punch by Hajek-Kofler**, 90° upbiting, 360° rotatable, WL 17 cm, width 3 mm
Knochenstanze nach Hajek-Kofler, 90° nach oben schneidend, 360° drehbar, NL 17 cm, Schnittbreite 3 mm



413200FX **Sphenoid Punch by McKenty**, through-cutting, rotatable, WL 14.5 cm, width 2 mm
Keilbeinstanze nach McKenty, durchschneidend, drehbar, NL 14,5 cm, Schnittbreite 2 mm



234603FX



234603FX **Circular Cutting Punch**, 70° upcurved, with flush connector, WL 13 cm, Ø 3.5 mm
Rundkopfstanze, 70° aufgebogen, mit Spülanschluss, NL 13 cm, Ø 3,5 mm

234606FX **Circular Cutting Punch**, 70° upcurved, with flush connector, WL 13 cm, Ø 4.5 mm
Rundkopfstanze, 70° aufgebogen, mit Spülanschluss, NL 13 cm, Ø 4,5 mm



412702FX



- 412702FX** **Frontal Sinus Punch**, 70° upturned sheath, 40° upbiting, WL 14 cm, width 2 mm
Stirnhöhlenstanze, 70° aufgebog.Schaft, 40° oben schneidend, NL 14 cm, Schnittbreite 2 mm
- 412703FX** **Frontal Sinus Punch**, 70° upturned sheath, 40° upbiting, WL 14 cm, width 3 mm
Stirnhöhlenstanze, 70° aufgebog.Schaft, 40° oben schneidend, NL 14 cm, Schnittbreite 3 mm

Sinus Surgery
Nasennebenhöhlen



234835FX

234835FX **Circular Cutting Punch**, straight, with flush connector, WL 16 cm, Ø 3.5 mm
Rundkopfstanze, gerade, mit Spülanschluss, NL 16 cm, Ø 3,5 mm

234845FX **Circular Cutting Punch**, straight, with flush connector, WL 16 cm, Ø 4.5 mm
Rundkopfstanze, gerade, mit Spülanschluss, NL 16 cm, Ø 4,5 mm



234865FX

234865FX **Circular Cutting Punch**, 65° upturned, with flush connector, WL 16 cm, Ø 3.5 mm
Rundkopfstanze, 65° aufgebogen, mit Spülanschluss, NL 16 cm, Ø 3,5 mm

234866FX **Circular Cutting Punch**, 65° upturned, with flush connector, WL 16 cm, Ø 4.5 mm
Rundkopfstanze, 65° aufgebogen, mit Spülanschluss, NL 16 cm, Ø 4,5 mm



235036FXF



235036FXF **Circular Cutting Punch (Gear Type)**, straight, with flush connector, WL 18 cm, Ø 3.5 mm
Rundkopfstanze (Zahnradmechanik), gerade, mit Spülanschluss, NL 18 cm, Ø 3,5 mm



235046FXF



235046FXF **Circular Cutting Punch (Gear Type)**, straight, with flush connector, WL 18 cm, Ø 4.5 mm
Rundkopfstanze (Zahnradmechanik), gerade, mit Spülanschluss, NL 18 cm, Ø 4,5 mm

Sinus Surgery
Nasennebenhöhlen



235066FXF



235066FXF **Circular Cutting Punch (Gear Type)**, 65° upturned, with flush connector, WL 18 cm, Ø 3.5 mm
Rundkopfstanze (Zahnradmechanik), 65° aufgebogen, mit Spülanschluss, NL 18 cm, Ø 3,5 mm



235076FXF

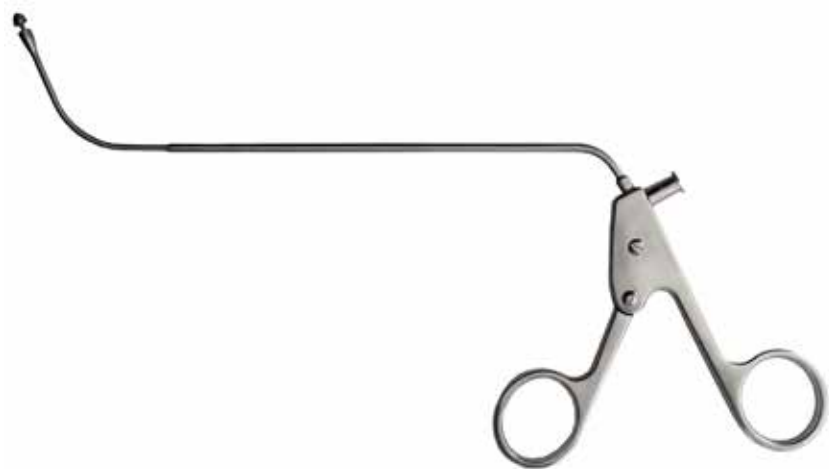

235076FXF **Circular Cutting Punch (Gear Type)**, 65° upturned, with flush connector, WL 18 cm, Ø 4.5 mm
Rundkopfstanze (Zahnradmechanik), 65° aufgebogen, mit Spülanschluss, NL 18 cm, Ø 4,5 mm



235035FXF

235035FX **Circular Cutting Punch**, straight, WL 18 cm, Ø 3.5 mm
Rundkopfstanze, gerade, NL 18 cm, Ø 3,5 mm

235035FX	straight / WL 18 cm, Ø 3.5 mm	gerade / NL 18 cm, Ø 3,5 mm
235035FXF	straight, with flush connector / WL 18 cm, Ø 3.5 mm	gerade, mit Spülanschluss / NL 18 cm, Ø 3,5 mm
235045FX	straight / WL 18 cm, Ø 4.5 mm	gerade / NL 18 cm, Ø 4,5 mm
235045FXF	straight, with flush connector / WL 18 cm, Ø 4.5 mm	gerade, mit Spülanschluss / NL 18 cm, Ø 4,5 mm

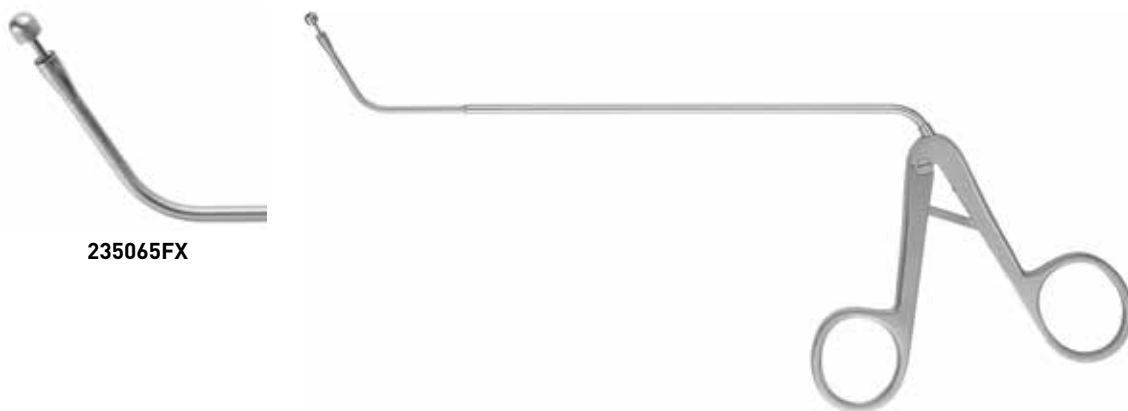

235065FX

235065FX **Circular Cutting Punch**, 60° upturned, WL 18 cm, Ø 3.5 mm
Rundkopfstanze, 60° aufgebogen, NL 18 cm, Ø 3,5 mm

235065FX	60° upturned / WL 18 cm, Ø 3.5 mm 60° aufgebogen / NL 18 cm, Ø 3,5 mm
235065FXF	60° upturned, with flush connector / WL 18 cm, Ø 3.5 mm 60° aufgebogen, mit Spülanschluss / NL 18 cm, Ø 3,5 mm
235075FX	60° upturned / WL 18 cm, Ø 4.5 mm 60° aufgebogen / NL 18 cm, Ø 4,5 mm
235075FXF	60° upturned, with flush connector / WL 18 cm, Ø 4.5 mm 60° aufgebogen, mit Spülanschluss / NL 18 cm, Ø 4,5 mm

Sinus Surgery
Nasennebenhöhlen



234613FX

234613FX **Circular Cutting Punch**, forward cutting, with flush connector, WL 16 cm, Ø 3.5 mm
Rundkopfstanze, vorwärts schneidend, mit Spülanschluss, NL 16 cm, Ø 3,5 mm

234616FX **Circular Cutting Punch**, forward cutting, with flush connector, WL 16 cm, Ø 4.5 mm
Rundkopfstanze, vorwärts schneidend, mit Spülanschluss, NL 16 cm, Ø 4,5 mm



234623FX

234623FX **Circular Cutting Punch**, reverse cutting, with flush connector, WL 16 cm, Ø 3.5 mm
Rundkopfstanze, rückwärts schneidend, mit Spülanschluss, NL 16 cm, Ø 3,5 mm

234626FX **Circular Cutting Punch**, reverse cutting, with flush connector, WL 16 cm, Ø 4.5 mm
Rundkopfstanze, rückwärts schneidend, mit Spülanschluss, NL 16 cm, Ø 4,5 mm



236311FX **Frontal Sinus Punch**, 45°, vertical, with flush connector, WL 13 cm, Ø 2 mm through-cutting
Stirnhöhlen-Stanze, 45°, vertikal, mit Spülanschluss, NL 13 cm, Ø 2 mm durchschneidend

236311FX 45°, vertical, with flush connector / WL 13 cm, Ø 2 mm through-cutting
 45°, vertikal, mit Spülanschluss / NL 13 cm, Ø 2 mm durchschneidend

236312FX 45°, horizontal, with flush connector / WL 13 cm, Ø 2 mm through-cutting
 45°, horizontal, mit Spülanschluss / NL 13 cm, Ø 2 mm durchschneidend

236313FX 90°, vertical, with flush connector / WL 13 cm, Ø 2 mm through-cutting
 90°, vertikal, mit Spülanschluss / NL 13 cm, Ø 2 mm durchschneidend

236314FX 90°, horizontal, with flush connector / WL 13 cm, Ø 2 mm through-cutting
 90°, horizontal, mit Spülanschluss / NL 13 cm, Ø 2 mm durchschneidend

236333FX 45°, vertical, with flush connector / WL 13 cm, Ø 3 mm through-cutting
 45°, vertikal, mit Spülanschluss / NL 13 cm, Ø 3 mm durchschneidend

236334FX 45°, horizontal, with flush connector / WL 13 cm, Ø 3 mm through-cutting
 45°, horizontal, mit Spülanschluss / NL 13 cm, Ø 3 mm durchschneidend

236343FX 90°, vertical, with flush connector / WL 13 cm, Ø 3 mm through-cutting
 90°, vertikal, mit Spülanschluss / NL 13 cm, Ø 3 mm durchschneidend

236344FX 90°, horizontal, with flush connector / WL 13 cm, Ø 3 mm through-cutting
 90°, horizontal, mit Spülanschluss / NL 13 cm, Ø 3 mm durchschneidend

Sinus Surgery
Nasennebenhöhlen



236301FX

236301FX **Frontal Sinus Punch**, 55°, vertical, WL 14.5 cm, Ø 2 mm through-cutting
Stirnhöhlen-Stanze, 55°, vertikal, NL 14,5 cm, Ø 2 mm durchschneidend

236301FX 55°, vertical / WL 14.5 cm, Ø 2 mm through-cutting
 55°, vertikal / NL 14,5 cm, Ø 2 mm durchschneidend

236301FXF 55°, vertical, with flush connector / WL 14.5 cm, Ø 2 mm through-cutting
 55°, vertikal, mit Spülanschluss / NL 14,5 cm, Ø 2 mm durchschneidend

236302FX 55°, horizontal / WL 14.5 cm, Ø 2 mm through-cutting
 55°, horizontal / NL 14,5 cm, Ø 2 mm durchschneidend

236302FXF 55°, horizontal, with flush connector / WL 14.5 cm, Ø 2 mm through-cutting
 55°, horizontal, mit Spülanschluss / NL 14,5 cm, Ø 2 mm durchschneidend



236303FX

236303FX **Frontal Sinus Punch**, 90°, vertical, WL 14.5 cm, Ø 2 mm through-cutting
Stirnhöhlen-Stanze, 90°, vertikal, NL 14,5 cm, Ø 2 mm durchschneidend

236303FX 90°, vertical / WL 14.5 cm, Ø 2 mm through-cutting
 90°, vertikal / NL 14,5 cm, Ø 2 mm durchschneidend

236303FXF 90°, vertical, with flush connector / WL 14.5 cm, Ø 2 mm through-cutting
 90°, vertikal, mit Spülanschluss / NL 14,5 cm, Ø 2 mm durchschneidend

236304FX 90°, horizontal / WL 14.5 cm, Ø 2 mm through-cutting
 90°, horizontal / NL 14,5 cm, Ø 2 mm durchschneidend

236304FXF 90°, horizontal, with flush connector / WL 14.5 cm, Ø 2 mm through-cutting
 90°, horizontal, mit Spülanschluss / NL 14,5 cm, Ø 2 mm durchschneidend



235501FX **Double Spoon Forceps**, 55°, vertical, WL 14.5 cm, spoon Ø 3 mm
Doppellöffel-Zange, 55°, vertikal, NL 14,5 cm, Löffel Ø 3 mm

235503FX 55°, vertical / WL 14.5 cm, spoon Ø 2 mm
 55°, vertikal / NL 14,5 cm, Löffel Ø 2 mm

235504FX 55°, horizontal / WL 14.5 cm, spoon Ø 2 mm
 55°, horizontal / NL 14,5 cm, Löffel Ø 2 mm

235501FX 55°, vertical / WL 14.5 cm, spoon Ø 3 mm
 55°, vertikal / NL 14,5 cm, Löffel Ø 3 mm

235501FXF 55°, vertical, with flush connector / WL 14.5 cm, spoon Ø 3 mm
 55°, vertikal, mit Spülanschluss / NL 14,5 cm, Löffel Ø 3 mm

235502FX 55°, horizontal / WL 14.5 cm, spoon Ø 3 mm
 55°, horizontal / NL 14,5 cm, Löffel Ø 3 mm

235502FXF 55°, horizontal, with flush connector / WL 14.5 cm, spoon Ø 3 mm
 55°, horizontal, mit Spülanschluss / NL 14,5 cm, Löffel Ø 3 mm

235513FX 55°, vertical / WL 14.5 cm, spoon Ø 4 mm
 55°, vertikal / NL 14,5 cm, Löffel Ø 4 mm

235513FXF 55°, vertical, with flush connector / WL 14.5 cm, spoon Ø 4 mm
 55°, vertikal, mit Spülanschluss / NL 14,5 cm, Löffel Ø 4 mm

235514FX 55°, horizontal / WL 14.5 cm, spoon Ø 4 mm
 55°, horizontal / NL 14,5 cm, Löffel Ø 4 mm

235514FXF 55°, horizontal, with flush connector / WL 14.5 cm, spoon Ø 4 mm
 55°, horizontal, mit Spülanschluss / NL 14,5 cm, Löffel Ø 4 mm

Sinus Surgery
Nasennebenhöhlen



235505FX **Double Spoon Forceps**, 90°, vertical, WL 14.5 cm, spoon Ø 2 mm
Doppellöffel-Zange, 90°, vertikal, NL 14,5 cm, Löffel Ø 2 mm

235505FX 90°, vertical / WL 14.5 cm, spoon Ø 2 mm
 90°, vertikal / NL 14,5 cm, Löffel Ø 2 mm

235505FXF 90°, vertical, with flush connector / WL 14.5 cm, spoon Ø 2 mm
 90°, vertikal, mit Spülanschluss / NL 14,5 cm, Löffel Ø 2 mm

235506FX 90°, horizontal / WL 14.5 cm, spoon Ø 2 mm
 90°, horizontal / NL 14,5 cm, Löffel Ø 2 mm

235506FXF 90°, horizontal, with flush connector / WL 14.5 cm, spoon Ø 2 mm
 90°, horizontal, mit Spülanschluss / NL 14,5 cm, Löffel Ø 2 mm

235507FX 90°, vertical / WL 14.5 cm, spoon Ø 3 mm
 90°, vertikal / NL 14,5 cm, Löffel Ø 3 mm

235508FX 90°, horizontal / WL 14.5 cm, spoon Ø 3 mm
 90°, horizontal / NL 14,5 cm, Löffel Ø 3 mm

235508FXF 90°, horizontal, with flush connector / WL 14.5 cm, spoon Ø 3 mm
 90°, horizontal, mit Spülanschluss / NL 14,5 cm, Löffel Ø 3 mm

235509FX 90°, vertical / WL 14.5 cm, spoon Ø 4 mm
 90°, vertikal / NL 14,5 cm, Löffel Ø 4 mm

235509FXF 90°, vertical, with flush connector / WL 14.5 cm, spoon Ø 4 mm
 90°, vertikal, mit Spülanschluss / NL 14,5 cm, Löffel Ø 4 mm

235510FX 90°, horizontal / WL 14.5 cm, spoon Ø 4 mm
 90°, horizontal / NL 14,5 cm, Löffel Ø 4 mm

235510FXF 90°, horizontal, with flush connector / WL 14.5 cm, spoon Ø 4 mm
 90°, horizontal, mit Spülanschluss / NL 14,5 cm, Löffel Ø 4 mm



235224FX



235224FX **Double Spoon Forceps**, 110°, vertical, oval, WL 14 cm, spoon Ø 4 mm
Doppellöffel-Zange, 110°, vertikal, NL 14 cm, Löffel Ø 4 mm

235210FX	110°, horizontal, oval / WL 14 cm, spoon Ø 2.6 mm	110°, horizontal / NL 14 cm, Löffel Ø 2,6 mm
235211FX	110°, vertical, oval / WL 14 cm, spoon Ø 2.6 mm	110°, vertikal, oval / NL 14 cm, Löffel Ø 2,6 mm
235214FX	110°, horizontal, oval / WL 14 cm, spoon Ø 4 mm	110°, horizontal, oval / NL 14 cm, Löffel Ø 4 mm
235224FX	110°, vertical, oval / WL 14 cm, spoon Ø 4 mm	110°, vertikal / NL 14 cm, Löffel Ø 4 mm



235270FX



235270FX **Double Spoon Forceps**, 70°, horizontal, oval, WL 14 cm, spoon Ø 2.6 mm
Doppellöffel-Zange, 70°, horizontal, NL 14 cm, Löffel Ø 2,6 mm

235270FX	70°, horizontal, oval / WL 14 cm, spoon Ø 2.6 mm 70°, horizontal / NL 14 cm, Löffel Ø 2,6 mm
-----------------	---

235270FXF	70°, horiz., oval, with flush connector / WL 14 cm, spoon Ø 2.6 mm 70°, horizontal, mit Spülanschluss / NL 14 cm, Löffel Ø 2,6 mm
------------------	--

235271FX	70°, vertical, oval / WL 14 cm, spoon Ø 2.6 mm 70°, vertikal / NL 14 cm, Löffel Ø 2,6 mm
-----------------	---

235271FXF	70°, vert., oval, with flush connector / WL 14 cm, spoon Ø 2.6 mm 70°, vertikal, mit Spülanschluss / NL 14 cm, Löffel Ø 2,6 mm
------------------	---



415100FX **Biopsy and Grasping Forceps**, double-action, oval, w. flush connector, WL 15 cm, spoon 2.5 x 3 mm
Probeexzisions- und Fasszange, doppelbeweglich, oval, mit Spülanschluss, NL 15 cm, Löffel 2,5 x 3 mm



415105FX

415105FX **Biopsy and Grasping Forceps**, double-action, round, WL 18 cm, spoon \varnothing 4 mm
Probeexzisions- und Fasszange, doppelbeweglich, rund, NL 18 cm, Löffel \varnothing 4 mm



415170FX **Maxillary Biopsy Forceps**, sheath 70° down, vertical opening, WL 12 cm, spoon Ø 3 mm
Kieferhöhlen Probeexzisionszange, Schaft 70° abgebogen, vertikal öffnend, NL 12 cm, Löffel Ø 3 mm

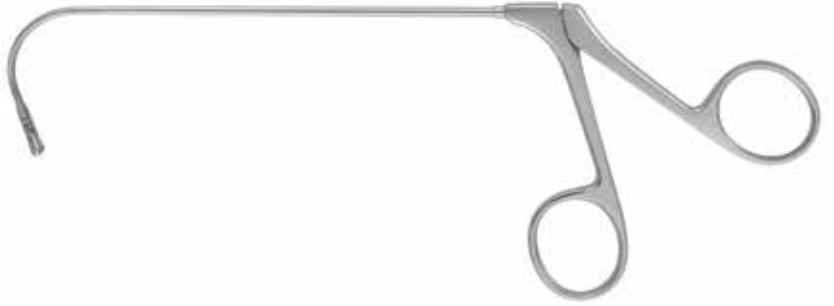

415210FX **Maxillary Biopsy Forceps**, sheath 110° down, horizontal opening, WL 13 cm, spoon 3 x 6 mm, with LL
Kieferhöhlen Probeexzisionszange, Schaft 110° abgebogen, seitlich öffnend, NL 13 cm, Löffel 3 x 6 mm, mit LL



236500FX



236501FX



236502FX

236500FX **S-Bite Nasal Forceps**, straight, serrated, through-cutting, WL 13 cm, bite 2 mm
S-Bite Nasenzange, gerade, gezahnt, durchschneidend, NL 13 cm, Ausstanzung 2 mm

236500FX straight, serrated, through-cutting / WL 13 cm, bite 2 mm
gerade, gezahnt, durchschneidend / NL 13 cm, Ausstanzung 2 mm

236501FX straight, serrated, through-cutting / WL 13 cm, bite 2.5 mm
gerade, gezahnt, durchschneidend / NL 13 cm, Ausstanzung 2,5 mm

236502FX straight, serrated, through-cutting / WL 13 cm, bite 3 mm
gerade, gezahnt, durchschneidend / NL 13 cm, Ausstanzung 3 mm



236600FX



236601FX



236602FX

236600FX **S-Bite Nasal Forceps**, 45° upcurved, serrated, through-cutting, WL 13 cm, bite 2 mm
S-Bite Nasenzange, 45° aufgebogen, gezahnt, durchschneidend, NL 13 cm, Ausstanzung 2 mm

236600FX 45° upcurved, serrated, through-cutting / WL 13 cm, bite 2 mm
 45° aufgebogen, gezahnt, durchschneidend / NL 13 cm, Ausstanzung 2 mm

236601FX 45° upcurved, serrated, through-cutting / WL 13 cm, bite 2.5 mm
 45° aufgebogen, gezahnt, durchschneidend / NL 13 cm, Ausstanzung 2,5 mm

236602FX 45° upcurved, serrated, through-cutting / WL 13 cm, bite 3 mm
 45° aufgebogen, gezahnt, durchschneidend / NL 13 cm, Ausstanzung 3 mm

Sinus Surgery
Nasennebenhöhlen



235300FX



235300FX **Suction Forceps by Gruenwald**, straight, through-cutting, WL 10 cm, bite 2 mm
Saugzange nach Grünwald, gerade, durchschneidend, NL 10 cm, Ausschnitt 2 mm



235301FX



235301FX **Suction Forceps by Gruenwald**, 45° upturned, through-cutting, WL 10 cm, bite 2 mm
Saugzange nach Grünwald, 45°, aufgebogen, durchschneidend, NL 10 cm, Ausschnitt 2 mm



236702FX



236702FX **S-Bite Nasal Forceps**, 70°, vertical, serrated, through-cutting, WL 13 cm, bite 2 mm, long curved
S-Bite Nasenzange, 70°, vertikal, gezahnt, durchschneidend, NL 13 cm, Ausschnitt 2 mm, lange Biegung

236702FX 70°, vertical, serrated, through-cutting / WL 13 cm, bite 2 mm, long curved
 70°, vertikal, gezahnt, durchschneidend / NL 13 cm, Ausschnitt 2 mm, lange Biegung

236703FX 70°, right, serrated, through-cutting / WL 13 cm, bite 2 mm, long curved
 70°, rechts, gezahnt, durchschneidend / NL 13 cm, Ausschnitt 2 mm, lange Biegung

236704FX 70° left, serrated, through-cutting / WL 13 cm, bite 2 mm, long curved
 70° links, gezahnt, durchschneidend / NL 13 cm, Ausschnitt 2 mm, lange Biegung

236712FX 70°, vertical, serrated, through-cutting / WL 13 cm, bite 2 mm, short curved
 70°, vertikal, gezahnt, durchschneidend / NL 13 cm, Ausschnitt 2 mm, kurze Biegung

Sinus Surgery
Nasennebenhöhlen



226901FX



226901FX **Nasal Forceps**, straight, through cutting, small, WL 14 cm
Nasenzange, gerade, durchschneidend, klein, NL 14 cm



226902FX



226902FX **Nasal Forceps**, 45° upturned, through-cutting, small, WL 14 cm
Nasenzange, 45° aufgebogen, durchschneidend, klein, NL 14 cm



226903FX



226903FX **Nasal Forceps**, shaft curved up, through-cutting, small, WL 14 cm
Nasenzange, Schaft aufgebog., durchschneidend, klein, NL 14 cm

Sinus Surgery
Nasennebenhöhlen



226915FX



226915FX

Nasal Forceps, 45° upturned, through-cutting, small, WL 14 cm
Nasenzange, 45° aufgebogen, durchschneidend, klein, NL 14 cm



226904FX



226904FX

Nasal Spoon Forceps, straight, oval cup, WL 14 cm
Nasenlöffelzange, gerade, ovaler Löffel, NL 14 cm

Sinus Surgery
Nasennebenhöhlen



226905FX



226905FX **Nasal Spoon Forceps**, 45° upturned, oval cup, WL 14 cm
Nasenlöffelzange, 45° aufgebogen, ovaler Löffel, NL 14 cm



226906FX



226906FX **Nasal Spoon Forceps**, shaft curved up, oval cup, WL 14 cm
Nasenlöffelzange, Schaft aufgebogen, ovaler Löffel, NL 14 cm

Sinus Surgery
Nasennebenhöhlen



226907FX



226907FX

Nasal Forceps, shaft curved up, backbiting, WL 14 cm

Nasenzange, Schaft aufgebogen, rückwärts schneidend, NL 14 cm



226908FX



226908FX

Nasal Forceps, shaft curved up, through-cutting, large, WL 14 cm

Nasenzange, Schaft aufgebog., durchschneidend, groß, NL 14 cm



226909FX



226909FX

Nasal Spoon Forceps, shaft curved up, oval cup, medium, WL 14 cm

Nasenlöffelzange, Schaft aufgebog., ovaler Löffel, mittel, NL 14 cm

Sinus Surgery
Nasennebenhöhlen



226910FX



226910FX **Nasal Forceps**, straight, through-cutting, small, WL 11.5 cm
Nasenzange, gerade, durchschneidend, klein, NL 11,5 cm



226911FX



226911FX **Nasal Forceps**, straight, through-cutting, large, WL 11.5 cm
Nasenzange, gerade, durchschneidend, groß, NL 11,5 cm



226912FX



226912FX

Nasal Forceps, 45° upturned, through-cutting, small, WL 11.5 cm
Nasenzange, 45° aufgebogen, durchschneidend, klein, NL 11,5 cm



226913FX



226913FX

Nasal Forceps, 45° upturned, through-cutting, medium, WL 11.5 cm
Nasenzange, 45° aufgebogen, durchschneidend, mittel, NL 11,5 cm

Sinus Surgery
Nasennebenhöhlen



226914FX



226914FX





Nasal Forceps, 45° upturned, through-cutting, large, WL 11.5 cm

Nasenzange, 45° aufgebogen, durchschneidend, groß, NL 11,5 cm



230100FX **Nasal Forceps by Blakesley**, straight, WL 11 cm, size 0
Nasenzange nach Blakesley, gerade, NL 11 cm, Fig. 0



Pattern Schneide	Size Fig.	0°	45°	90°
	0 = 3,0 mm	230100FX	230200FX	230300FX
	1 = 3,5 mm	230101FX	230201FX	230301FX
	2 = 4,0 mm	230102FX	230202FX	230302FX
	3 = 5,0 mm	230103FX	230203FX	230303FX
	4 = 5,5 mm	230104FX	230204FX	-

230100FX	straight / WL 11 cm, size 0	gerade / NL 11 cm, Fig. 0
230101FX	straight / WL 11 cm, size 1	gerade / NL 11 cm, Fig. 1
230102FX	straight / WL 11 cm, size 2	gerade / NL 11 cm, Fig. 2
230103FX	straight / WL 11 cm, size 3	gerade / NL 11 cm, Fig. 3
230104FX	straight / WL 11 cm, size 4	gerade / NL 11 cm, Fig. 4
230200FX	45° upturned / WL 11 cm, size 0	45° aufgebogen / NL 11 cm, Fig. 0
230201FX	45° upturned / WL 11 cm, size 1	45° aufgebogen / NL 11 cm, Fig. 1
230202FX	45° upturned / WL 11 cm, size 2	45° aufgebogen / NL 11 cm, Fig. 2
230203FX	45° upturned / WL 11 cm, size 3	45° aufgebogen / NL 11 cm, Fig. 3
230204FX	45° upturned / WL 11 cm, size 4	45° aufgebogen / NL 11 cm, Fig. 4
230300FX	90° upturned / WL 11 cm, size 0	90° aufgebogen / NL 11 cm, Fig. 0
230301FX	90° upturned / WL 11 cm, size 1	90° aufgebogen / NL 11 cm, Fig. 1
230302FX	90° upturned / WL 11 cm, size 2	90° aufgebogen / NL 11 cm, Fig. 2
230303FX	90° upturned / WL 11 cm, size 3	90° aufgebogen / NL 11 cm, Fig. 3



231601FX **Nasal Forceps by Blakesley**, straight, WL 15 cm, size 1
Nasenzange nach Blakesley, gerade, NL 15 cm, Fig. 1



Pattern Schneide	Size Fig.	0°	45°	90°
	1 = 3,5 mm	231601FX	231701FX	231801FX
	2 = 4,0 mm	231602FX	231702FX	231802FX
	3 = 5,0 mm	231603FX	-	-

231601FX	straight / WL 15 cm, size 1	gerade / NL 15 cm, Fig. 1
231602FX	straight / WL 15 cm, size 2	gerade / NL 15 cm, Fig. 2
231603FX	straight / WL 15 cm, size 3	gerade / NL 15 cm, Fig. 3
231701FX	45° upturned / WL 15 cm, size 1	45° aufgebogen / NL 15 cm, Fig. 1
231702FX	45° upturned / WL 15 cm, size 2	45° aufgebogen / NL 15 cm, Fig. 2
231801FX	90° upturned / WL 15 cm, size 1	90° aufgebogen / NL 15 cm, Fig. 1
231802FX	90° upturned / WL 15 cm, size 2	90° aufgebogen / NL 15 cm, Fig. 2



230140FX **Nasal Forceps by Blakesley**, straight, semi-detachable, WL 12 cm, Size 0
Nasenzange nach Blakesley, gerade, teilzerlegbar, NL 12 cm, Fig. 0

230140FX straight, semi-detachable / WL 12 cm, Size 0
gerade, teilzerlegbar / NL 12 cm, Fig. 0

230141FX straight, semi-detachable / WL 12 cm, Size 1
gerade, teilzerlegbar / NL 12 cm, Fig. 1

230142FX straight, semi-detachable / WL 12 cm, size 2
gerade, teilzerlegbar / NL 12 cm, Fig. 2

230240FX 45° upturned, semi-detachable / WL 12 cm, Size 0
45° aufgebogen, teilzerlegbar / NL 12 cm, Fig. 0

230241FX 45° upturned, semi-detachable / WL 12 cm, Size 1
45° aufgebogen, teilzerlegbar / NL 12 cm, Fig. 1

230242FX 45° upturned, semi-detachable / WL 12 cm, Size 2
45° aufgebogen, teilzerlegbar / NL 12 cm, Fig. 2

230340FX 90° upturned, semi-detachable / WL 12 cm, Size 0
90° aufgebogen, teilzerlegbar / NL 12 cm, Fig. 0

230341FX 90° upturned, semi-detachable / WL 12 cm, Size 1
90° aufgebogen, teilzerlegbar / NL 12 cm, Fig. 1

230342FX 90° upturned, semi-detachable / WL 12 cm, Size 2
90° aufgebogen, teilzerlegbar / NL 12 cm, Fig. 2



230600FX **Nasal Forceps by Blakesley**, curved left, WL 10 cm, size 1
Nasenzange nach Blakesley, nach links gebogen, NL 10 cm, Fig. 1

230700FX **Nasal Forceps by Blakesley**, curved right, WL 10 cm, size 1
Nasenzange nach Blakesley, nach rechts gebogen, NL 10 cm, Fig. 1



236900FX



236900FX **Suction Forceps by Blakesley**, straight, WL 10 cm, size 0
Saugzange nach Blakesley, gerade, NL 10 cm, Fig. 0

236900FX	straight / WL 10 cm, size 0	gerade / NL 10 cm, Fig. 0
236901FX	straight / WL 10 cm, size 1	gerade / NL 10 cm, Fig. 1
236902FX	straight / WL 10 cm, size 2	gerade / NL 10 cm, Fig. 2

Sinus Surgery
Nasennebenhöhlen



237000FX



237000FX **Suction Forceps by Blakesley**, 30° upturned, WL 10 cm, size 0
Saugzange nach Blakesley, 30° aufgebogen, NL 10 cm, Fig. 0

237000FX	30° upturned / WL 10 cm, size 0	30° aufgebogen / NL 10 cm, Fig. 0
237001FX	30° upturned / WL 10 cm, size 1	30° aufgebogen / NL 10 cm, Fig. 1
237002FX	30° upturned / WL 10 cm, size 2	30° aufgebogen / NL 10 cm, Fig. 2



235900FX



235900FX **Nasal Forceps by Blakesley**, straight, through-cutting, WL 11 cm, size 0
Nasenzange nach Blakesley, gerade, durchschneidend, NL 11 cm, Fig. 0

235900FX	straight, through-cutting / WL 11 cm, size 0	gerade, durchschneidend / NL 11 cm, Fig. 0
235901FX	straight, through-cutting / WL 11 cm, size 1	gerade, durchschneidend / NL 11 cm, Fig. 1
235902FX	straight, through-cutting / WL 11 cm, size 2	gerade, durchschneidend / NL 11 cm, Fig. 2

Sinus Surgery
Nasennebenhöhlen



236000FX



236000FX **Nasal Forceps by Blakesley**, 45° upturned, through-cutting, WL 11 cm, size 0
Nasenzange nach Blakesley, 45° aufgebogen, durchschneidend, NL 11 cm, Fig. 0

236000FX 45° upturned, through-cutting / WL 11 cm, size 0
 45° aufgebogen, durchschneidend / NL 11 cm, Fig. 0

236001FX 45° upturned, through-cutting / WL 11 cm, size 1
 45° aufgebogen, durchschneidend / NL 11 cm, Fig. 1

236002FX 45° upturned, through-cutting / WL 11 cm, size 2
 45° aufgebogen, durchschneidend / NL 11 cm, Fig. 2



227600FX



227600FX **Nasal Cutting Forceps by Struycken**, WL 11 cm
Conchotom nach Struycken, NL 11 cm



228601FX **Nasal Cutting Forceps by Gruenwald-Henke**, through-cutting, WL 11 cm, size 1
Conchotom nach Grünwald-Henke, durchschneidend, NL 11 cm, Fig. 1

228601FX	through-cutting / WL 11 cm, size 1	durchschneidend / NL 11 cm, Fig. 1
228602FX	through-cutting / WL 11 cm, size 2	durchschneidend / NL 11 cm, Fig. 2
228603FX	through-cutting / WL 11 cm, size 3	durchschneidend / NL 11 cm, Fig. 3



234300FX



234300FX **Nasal Forceps by Wigand**, straight, through-cutting, WL 14 cm, bite 3 x 4 mm
Nasenzange nach Wigand, gerade, durchschneidend, NL 14 cm, Schnittgröße 3 x 4 mm

234345FX **Nasal Forceps by Wigand**, 45° upcurved, through-cutting, WL 14 cm, bite 3 x 4 mm
Nasenzange nach Wigand, 45° aufgebogen, durchschneidend, NL 14 cm, Schnittgröße 3 x 4 mm



234400FX **Nasal Cutting Forceps by Wigand**, straight, through-cutting, large, WL 14 cm, bite 11.5 x 2.5 mm
Conchotom nach Wigand, gerade, durchschneidend, groß, NL 14 cm, Schnittgröße 11,5 x 2,5 mm



234400FX



234445FX



234500FX



234545FX

234400FX straight, through-cutting, large / WL 14 cm, bite 11.5 x 2.5 mm
gerade, durchschneidend, groß / NL 14 cm, Schnittgröße 11,5 x 2,5 mm

234445FX 30° upcurved, through-cutting, large / WL 14 cm, bite 11.5 x 2.5 mm
30° aufgebogen, durchschneidend, groß / NL 14 cm, Schnittgröße 11,5 x 2,5 mm

234500FX straight, through-cutting, small / WL 14 cm, bite 6 x 2 mm
gerade, durchschneidend, klein / NL 14 cm, Schnittgröße 6 x 2 mm

234545FX 30° upcurved, through-cutting, small / WL 14 cm, bite 6 x 2 mm
30° aufgebogen, durchschneidend, klein / NL 14 cm, Schnittgröße 6 x 2 mm



227100FX **Nasal Forceps by Takahashi**, straight, WL 12.5 cm, spoon 10 x 2,5 mm
Nasenzange nach Takahashi, gerade, NL 12,5 cm, Löffel 10 x 2,5 mm



227100FX

227101FX

227102FX

227100FX	straight / WL 12.5 cm, spoon 10 x 2,5 mm	gerade / NL 12,5 cm, Löffel 10 x 2,5 mm
227101FX	straight / WL 12.5 cm, spoon 10 x 3 mm	gerade / NL 12,5 cm, Löffel 10 x 3 mm
227102FX	45° upturned / WL 12.5 cm, spoon 10 x 3 mm	45° aufgebogen / NL 12,5 cm, Löffel 10 x 3 mm



238101FX **Suction Forceps by Takahashi**, straight, WL 10 cm, size 1 = 3.5 mm
Saugzange nach Takahashi, gerade, NL 10 cm, Fig. 1 = 3,5 mm



238101FX

238102FX

238201FX

238202FX

238101FX	straight / WL 10 cm, size 1 = 3.5 mm	gerade / NL 10 cm, Fig. 1 = 3,5 mm
238102FX	straight / WL 10 cm, size 2 = 2.5 mm	gerade / NL 10 cm, Fig. 2 = 2,5 mm
238201FX	45° upturned / WL 10 cm, size 1 = 3.5 mm	45° aufgebogen / NL 10 cm, Fig. 1 = 3,5 mm
238202FX	45° upturned / WL 10 cm, size 2 = 2.5 mm	45° aufgebogen / NL 10 cm, Fig. 2 = 2,5 mm



415600FX

415600FX **Antrum Grasping Forceps**, 90-120° backbiter, jaws curved downward, WL 10 cm
Kieferhöhlenfasszange, 90-120° rückwärts, Maulteil nach unten, NL 10 cm

415600FX 90-120° backbiter, jaws curved downward / WL 10 cm
 90-120° rückwärts, Maulteil nach unten / NL 10 cm

415600FXF 90-120° backbiter, jaws curved downward / WL 10 cm, with flush connector
 90-120° rückwärts, Maulteil nach unten / NL 10 cm, mit Spülanschluss

415601FX 90-120° backbiter, jaws curved upwards / WL 10 cm
 90-120° rückwärts, Maulteil nach oben / NL 10 cm

415602FX 90-120° backbiter, jaws curved to right / WL 10 cm
 90-120° rückwärts, Maulteil nach rechts / NL 10 cm

415603FX 90-120° backbiter, jaws curved to left / WL 10 cm
 90-120° rückwärts, Maulteil nach links / NL 10 cm

415604FX 140-155° backbiter, jaws curved downward / WL 10 cm
 140-155° rückwärts, Maul nach unten / NL 10 cm

415604FXF 140-155° backbiter, jaws curved downward / WL 10 cm, with flush connector
 140-155° rückwärts, Maul nach unten / NL 10 cm, mit Spülanschluss

415605FX 115-140° backbiter, jaws curved downward / WL 10 cm
 115-140° rückwärts, Maul nach unten / NL 10 cm

415605FXF 115-140° backbiter, jaws curved downward / WL 10 cm, with flush connector
 115-140° rückwärts, Maul nach unten / NL 10 cm, mit Spülanschluss

Sinus Surgery
Nasennebenhöhlen



415610FX

- 415610FX** **Antrum Grasping Forceps**, 90-120° backbiter, jaws curved downward, WL 10 cm, rotatable
Kieferhöhlenfasszange, 90-120° rückwärts, Maulteil nach unten, NL 10 cm, drehbar
- 415630FX** **Antrum Grasping Forceps**, 90-120° backbiter, jaws curved downward, WL 13 cm, rotatable
Kieferhöhlenfasszange, 90-120° rückwärts, Maulteil nach unten, NL 13 cm, drehbar



235100FX **Antrum Punch by Ostrum**, upside backwards, with flush connector, WL 10 cm, bite 2.5 mm
Antrumstanze nach Ostrum, nach oben rückwärts, mit Spülanschluss, NL 10 cm, Ausschnitt 2,5 mm



235101FX

235102FX

235100FX upside backwards, with flush connector / WL 10 cm, bite 2.5 mm
 nach oben rückwärts, mit Spülanschluss / NL 10 cm, Ausschnitt 2,5 mm

235101FX left backwards, with flush connector / WL 10 cm, bite 2.5 mm
 nach links rückwärts, mit Spülanschluss / NL 10 cm, Ausschnitt 2,5 mm

235102FX right backwards, with flush connector / WL 10 cm, bite 2.5 mm
 nach rechts rückwärts, mit Spülanschluss / NL 10 cm, Ausschnitt 2,5 mm



235120FX **Antrum Punch by Ostrum**, upside backwards, with flush connector, WL 10 cm, bite 1.5 mm
Antrumstanze nach Ostrum, nach oben rückwärts, mit Spülanschluss, NL 10 cm, Ausschnitt 1,5 mm



235120FX



235121FX



235122FX

235120FX upside backwards, with flush connector / WL 10 cm, bite 1.5 mm
 nach oben rückwärts, mit Spülanschluss / NL 10 cm, Ausschnitt 1,5 mm

235121FX left backwards, with flush connector / WL 10 cm, bite 1.5 mm
 nach links rückwärts, mit Spülanschluss / NL 10 cm, Ausschnitt 1,5 mm

235122FX right backwards, with flush connector / WL 10 cm, bite 1.5 mm
 nach rechts rückwärts, mit Spülanschluss / NL 10 cm, Ausschnitt 1,5 mm



235110FX



235110FX **Antrum Punch by Ostrum**, rotatable, backw., with flush connector, WL 10 cm, bite 2.5 mm
Antrumstanze nach Ostrum, drehbar, rückwärts, mit Spülanschluss, NL 10 cm, Ausschnitt 2,5 mm



235111FX



235111FX **Antrum Punch by Ostrum**, rotatable, backw., with flush connector, WL 10 cm, bite 1.5 mm
Antrumstanze nach Ostrum, drehbar, rückwärts, mit Spülanschluss, NL 10 cm, Ausschnitt 1,5 mm



235115FX



235115FX **Antrum Punch**, rotatable, backward cutting, WL 10 cm, bite 1.5 mm
Antrumstanze, drehbar, rückwärts schneidend, NL 10 cm, Ausschnitt 1,5 mm

Sinus Surgery
Nasennebenhöhlen



235125FX

235125FX **Antrum Punch**, rotatable, backward cutting, WL 10 cm, bite 2.5 mm
Antrumstanze, drehbar, rückwärts schneidend, NL 10 cm, Ausschnitt 2,5 mm

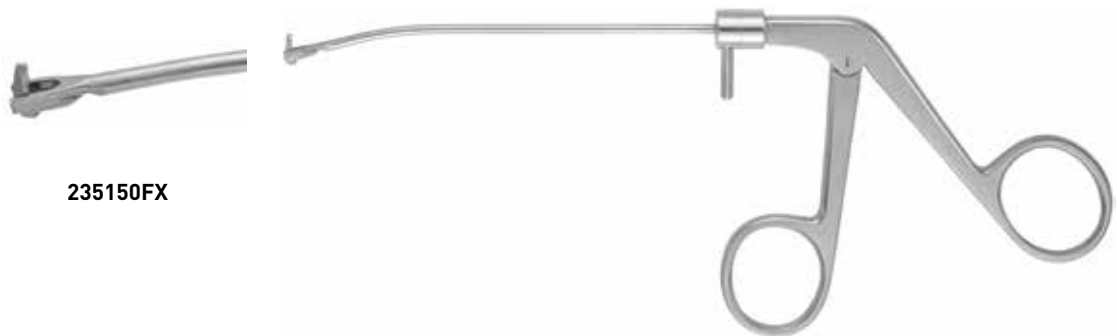

235150FX

235150FX **Antrum Punch by Tobey**, shaft curved, rotatable, backwards, WL 10 cm
Antrumstanze nach Tobey, Schaft abgebogen, drehbar, rückwärts, NL 10 cm



235200FX

235200FX **Antrum Suction Punch**, straight, upside backward cutting, WL 10 cm, bite 2.5 mm
Antrum-Saugstanze, gerade, nach oben rückwärts schneidend, NL 10 cm, Ausschnitt 2,5 mm

235200FX straight, upside backward cutting / WL 10 cm, bite 2.5 mm
gerade, nach oben rückwärts schneidend / NL 10 cm, Ausschnitt 2,5 mm

235201FX straight, left side backward cutting / WL 10 cm, bite 2.5 mm
gerade, nach links rückwärts schneidend / NL 10 cm, Ausschnitt 2,5 mm

235202FX straight, right side backward cutting / WL 10 cm, bite 2.5 mm
gerade, nach rechts rückwärts schneidend / NL 10 cm, Ausschnitt 2,5 mm

Sinus Surgery
Nasennebenhöhlen



234902FXF



234901FXF **Antrum Side-Biting Punch**, left side cutting, with flush connector, WL 10 cm
Antrum Seitwärtsstanze, linksschneidend, mit Spülanschluss, NL 10 cm

234902FXF **Antrum Side-Biting Punch**, right side cutting, with flush connector, WL 10 cm
Antrum Seitwärtsstanze, rechtsschneidend, mit Spülanschluss, NL 10 cm



234904FX



234903FX **Antrum Side-Biting Punch**, right side cutting, with flush connector, WL 10 cm
Antrum Seitwärtsstanze, rechtsschneidend, mit Spülanschluss, NL 10 cm

234904FX **Antrum Side-Biting Punch**, left side cutting, with flush connector, WL 10 cm
Antrum Seitwärtsstanze, linksschneidend, mit Spülanschluss, NL 10 cm



230500FX



230500FX **Polyp Grasping Forceps by Wigand**, 60° upturned, WL 11 cm, spoon 6 x 14 mm
Polypenfasszange nach Wigand, 60° aufgebogen, NL 11 cm, Löffel 6 x 14 mm

Sinus Surgery
Nasennebenhöhlen



234210FX



234210FX **Polyp Forceps by Watson-Williams**, WL 11 cm, size 1
Polypenzange nach Watson-Williams, NL 11 cm, Fig. 1

234220FX **Polyp Forceps by Watson-Williams**, WL 11 cm, size 2
Polypenzange nach Watson-Williams, NL 11 cm, Fig. 2



228100FX **Nasal Cutting Forceps by Schmeden**, through-cutting, WL 12 cm, size 0
Conchotom nach Schmeden, durchschneidend, NL 12 cm, Fig. 0

228100FX	through-cutting / WL 12 cm, size 0	durchschneidend / NL 12 cm, Fig. 0
228101FX	through-cutting / WL 12 cm, size 1	durchschneidend / NL 12 cm, Fig. 1
228102FX	through-cutting / WL 12 cm, size 2	durchschneidend / NL 12 cm, Fig. 2



228100FX



228101FX



228102FX



229101FX

229101FX **Nasal Cutting Forceps by Hartmann**, round, with grid, WL 11 cm, size 1
Conchotom nach Hartmann, rund, mit Fanggitter, NL 11 cm, Fig. 1

229101FX round, with grid / WL 11 cm, size 1
 rund, mit Fanggitter / NL 11 cm, Fig. 1



229102FX round, with grid / WL 11 cm, size 2
 rund, mit Fanggitter / NL 11 cm, Fig. 2



229103FX round, with grid / WL 11 cm, size 3
 rund, mit Fanggitter / NL 11 cm, Fig. 3



229104FX round, with grid / WL 11 cm, size 4
 rund, mit Fanggitter / NL 11 cm, Fig. 4



Sinus Surgery
Nasennebenhöhlen



241100FX **Forceps by Struempel**, straight, oval, fenestrated, WL 10 cm
Zängchen nach Strümpel, gerade, oval, gefenstert, NL 10 cm



241100FX



241145FX



241190FX

241100FX	straight, oval, fenestrated / WL 10 cm	gerade, oval, gefenstert / NL 10 cm
241145FX	45° upturned, oval, fenestrated / WL 10 cm	45° aufgebogen, oval, gefenstert / NL 10 cm
241190FX	90° upturned, oval, fenestrated / WL 10 cm	90° aufgebogen, oval, gefenstert / NL 10 cm



242100FX



242100FX **Scissors by Bellucci**, straight, WL 10 cm
Schere nach Bellucci, gerade, NL 10 cm



238519FX **Ethmoid Forceps by Draf**, straight, oval, fenestrated, WL 19 cm
Siebbeinzange nach Draf, gerade, oval, gefenstert, NL 19 cm

238513FX	straight, oval, fenestrated / WL 13 cm	gerade, oval, gefenstert / NL 13 cm
238516FX	straight, oval, fenestrated / WL 16 cm	gerade, oval, gefenstert / NL 16 cm
238519FX	straight, oval, fenestrated / WL 19 cm	gerade, oval, gefenstert / NL 19 cm



238613FX **Ethmoid Forceps by Draf**, 60° upturned, oval, fenestrated, WL 13 cm
Siebbeinzange nach Draf, 60° aufgebogen, oval, gefenstert, NL 13 cm

238613FX	60° upturned, oval, fenestrated / WL 13 cm	60° aufgebogen, oval, gefenstert / NL 13 cm
238616FX	60 ° upturned, oval, fenestrated / WL 16 cm	60° aufgebogen, oval, gefenstert / NL 16 cm
238619FX	60 ° upturned, oval, fenestrated / WL 19 cm	60° aufgebogen, oval, gefenstert / NL 19 cm

Sinus Surgery
Nasennebenhöhlen



238713FX

238713FX **Ethmoid Forceps by Draf**, 90 ° upturned, oval, fenestrated, WL 13 cm
Siebbeinzange nach Draf, 90° aufgebogen, oval, gefenstert, NL 13 cm

238713FX	90 ° upturned, oval, fenestrated / WL 13 cm	90° aufgebogen, oval, gefenstert / NL 13 cm
238716FX	90 ° upturned, oval fenestrated / WL 16 cm	90° aufgebogen, oval, gefenstert / NL 16 cm
238719FX	90 ° upturned, oval, fenestrated / WL 19 cm	90° aufgebogen, oval, gefenstert / NL 19 cm



226570FX **Nasal Spoon Forceps**, straight, round cup, Ø 2.5 mm, WL 18 cm
Nasenlöffelzange, gerade, runder Löffel, Ø 2,5 mm, NL 18 cm

Sinus Surgery
Nasennebenhöhlen



238813FX **Ethmoid Scissors by Draf**, straight, WL 13 cm
Siebbeinschere nach Draf, gerade, NL 13 cm

238816FX **Ethmoid Scissors by Draf**, straight, WL 16 cm
Siebbeinschere nach Draf, gerade, NL 16 cm



226540FX **Nasal Scissors**, straight, extra delicate, WL 19 cm
Nasenschere, gerade, extra zart, NL 19 cm

226540FX	straight, extra delicate / WL 19 cm	gerade, extra zart / NL 19 cm
226541FX	curved left, extra delicate / WL 19 cm	nach links gebogen, extra zart / NL 19 cm
226542FX	curved right, extra delicate / WL 19 cm	nach rechts gebogen, extra zart / NL 19 cm
226545FX	45° curved up, extra delicate / WL 19 cm	45° aufgebogen, extra zart / NL 19 cm

Sinus Surgery
Nasennebenhöhlen



239101FX **Micro Elevator by Draf**, slightly curved, 25 cm, width 1 mm
Mikro-Elevatorium nach Draf, leicht gebogen, 25 cm, Breite 1 mm

239101FX	slightly curved / 25 cm, width 1 mm	leicht gebogen / 25 cm, Breite 1 mm
239102FX	slightly curved / 25 cm, width 3 mm	leicht gebogen / 25 cm, Breite 3 mm
239103FX	strongly curved / 25 cm, width 3 mm	stark gebogen / 25 cm, Breite 3 mm
239104FX	angled / 25 cm, width 4 mm	abgewinkelt / 25 cm, Breite 4 mm



239301FX **Round Knife by Draf**, straight, 19 cm, Ø 1.5 mm
Rundschnittmesser nach Draf, gerade, 19 cm, Ø 1,5 mm

239301FX	straight / 19 cm, Ø 1.5 mm	gerade / 19 cm, Ø 1,5 mm
239302FX	bayonet-shaped / 19 cm, Ø 1.5 mm	bajonettförmig / 19 cm, Ø 1,5 mm
239401FX	45° angled, straight shaft / 19 cm, Ø 2 mm	45° abgewinkelt, gerader Schaft / 19 cm, Ø 2 mm
239402FX	bayonet-shaped / 19 cm, Ø 2 mm	bajonettförmig / 19 cm, Ø 2 mm
239501FX	straight, vertical cutting / 19 cm	gerade, vertikal schneidend / 19 cm
239502FX	bayonet-shaped, vertical cutting / 19 cm	bajonettförmig, vertikal schneidend / 19 cm



418350FX **Ring Curette by Cappabianca-de Divitiis**, lateral curved sheath end, sharp, Ø 3 mm
Ringkürette nach Cappabianca-de Divitiis, Schaftende seitlich gebogen, scharf, Ø 3 mm

418350FX lateral curved sheath end, sharp / Ø 3 mm Schaftende seitlich gebogen, scharf / Ø 3 mm

418351FX lateral curved sheath end, sharp / Ø 5 mm Schaftende seitlich gebogen, scharf / Ø 5 mm

418352FX tip angled 45°, sharp / Ø 3 mm Spitze 45° gewinkelt, scharf / Ø 3 mm

418353FX tip angled 45°, sharp / Ø 5 mm Spitze 45° gewinkelt, scharf / Ø 5 mm



419000FX **Hook**, blunt, 90° angled, 19 cm, 0.5 mm
Häkchen, stumpf, 90° abgewinkelt, 19 cm, 0,5 mm

Sinus Surgery
Nasennebenhöhlen







239003FX **Dissector**, tip 45° angled, sharp, 24 cm, 3 mm
Dissektor, Spitze 45° abgewinkelt, scharf, 24 cm, 3 mm







239201FX **Sickle Knife by Draf**, 19 cm
Sichelmesser nach Draf, 19 cm

Sinus Surgery
Nasennebenhöhlen

Length mm	Ø mm	Diamond, coarse	Diamond, fine	Round, stainless	Round, Tungsten carbide	Cross-Cut, Tungsten carbide
Länge mm	Ø mm	Diamant, grob	Diamant, fein	rund, rostfrei	rund, HM	Querhieb, HM
						
70	0.6	-	142106FX	136106FX	136206FX (9,5 mm)	-
70	0.7	-	142107FX	-	-	-
70	0.8	-	142108FX	136108FX	136208FX	-
70	1.0	-	142110FX	136110FX	136210FX	-
70	1.4	-	142114FX	136114FX	136214FX	136414FX
70	1.8	-	142118FX	136118FX	136218FX	-
70	2.1	-	142121FX	-	136221FX	-
70	2.3	142523FX	142123FX	136123FX	136223FX	136423FX
70	2.5	-	142125FX	-	-	-
70	2.7	142527FX	142127FX	136127FX	136227FX	-
70	3.1	142531FX	142131FX	136131FX	136231FX	136431FX
70	3.5	142535FX	142135FX	136135FX	136235FX	-
70	4.0	142540FX	142140FX	136140FX	136240FX	136440FX
70	4.5	142545FX	142145FX	136145FX	136245FX	-
70	5.0	142550FX	142150FX	136150FX	136250FX	136450FX
70	6.0	142560FX	142160FX	136160FX	136260FX	136460FX
70	6.5	-	-	-	-	-
70	7.0	142570FX	142170FX	136170FX	136270FX	-
-	-	-	-	-	-	-
95	0.6	-	250406FX	-	250806FX (0,5 mm)	-
95	0.8	-	-	-	250808FX	-
95	1.0	-	250410FX	-	250810FX	-
95	1.4	-	-	-	-	-
95	1.8	-	-	250318FX	250818FX	-
95	2.1	-	-	-	-	-
95	2.3	250723FX	250423FX	250323FX	250823FX	-
95	2.5	-	-	-	-	-
95	2.7	250727FX	250427FX	250327FX	-	-
95	3.1	250731FX	-	250331FX	250831FX	250931FX
95	3.5	-	250435FX	250335FX	250835FX	-
95	4.0	250740FX	250440FX	250340FX	250840FX	250940FX

Sinus Surgery

Nasennebenhöhlen

Length mm	Ø mm	Diamond, coarse	Diamond, fine	Round, stainless	Round, Tungsten carbide	Cross-Cut, Tungsten carbide
Länge mm	Ø mm	Diamant, grob	Diamant, fein	rund, rostfrei	rund, HM	Querhieb, HM
						
95	4.5	-	250445FX	250345FX	250845FX	-
95	5.0	-	250450FX	250350FX	250850FX	250950FX
95	6.0	-	-	250360FX	250860FX	250960FX
95	6.5	-	-	-	-	-
95	7.0	-	250470FX	250370FX	250870FX	-
125	0.6	-	260406FX	-	-	-
125	0.8	-	-	-	-	-
125	1.0	-	260410FX	-	-	-
125	1.4	-	-	-	-	-
125	1.8	-	260418FX	260318FX	-	-
125	2.1	-	260421FX	-	-	-
125	2.3	-	260423FX	260323FX	260823FX	-
125	2.5	-	260425FX	-	-	-
125	2.7	-	260427FX	260327FX	-	-
125	3.1	-	260431FX	260331FX	260831FX	-
125	3.5	-	260435FX	260335FX	-	-
125	4.0	-	260440FX	-	260840FX	-
125	4.5	-	260445FX	-	-	-
125	5.0	-	-	-	260850FX	-
125	6.0	-	260460FX	-	260860FX	-
125	6.5	-	-	-	-	-
125	7.0	-	260470FX	-	260870FX	-



829700FX **Handpiece**, straight, with external cooling, for 7 cm burrs
Bohrhandstück, gerade, mit externer Kühlung, für 7cm Bohrer

829700FX straight, with external cooling / for 7 cm burrs gerade, mit externer Kühlung / für 7cm Bohrer

829720FX straight, with external cooling / for 9.5 cm burrs gerade, mit externer Kühlung / für 9,5 cm Bohrer

829750FX straight, with external cooling / for 12.5 cm burrs gerade, mit externer Kühlung / für 12,5 cm Bohrer



829800FX **Handpiece**, angled, with external cooling, for 7 cm burrs
Bohrhandstück, abgewinkelt, mit externer Kühlung, für 7 cm Bohrer

829800FX angled, with external cooling / for 7 cm burrs abgewinkelt, mit externer Kühlung / für 7 cm Bohrer

829855FX angled, with external cooling / for 9.5 cm burrs abgewinkelt, mit externer Kühlung / für 9,5 cm Bohrer

829880FX angled, with external cooling / for 12.5 cm burrs abgewinkelt, mit externer Kühlung / für 12,5 cm Bohrer



118900FX **Flexible Arm with Holding Rod**
Flexibler Arm mit Haltestange



118901FX **Clamp**, for Flexible Arm 118900FX
Spannkloben, für Flexiblen Arm 118900FX



118903FX **Telescope Clamp**, for Flexible Arm 118900FX
Optik-Klammer, für Flexiblen Arm 118900FX



118904FX **Adapter**, for Flexible Arm 118900FX
Adapter, für Flexiblen Arm 118900FX

Sinus Surgery
Nasennebenhöhlen



397701FX **Nasal Speculum by Killian**, for 118900FX, right blade shortened, 15 cm, blade length left 55 mm
Nasenspekulum nach Killian, für 118900FX, rechtes Blatt gekürzt, 15 cm, Blattlänge links 55 mm



397702FX **Nasal Speculum by Killian**, for 118900FX, left blade shortened, 15 cm, blade length right 55 mm
Nasenspekulum nach Killian, für 118900FX, linkes Blatt gekürzt, 15 cm, Blattlänge rechts 55 mm



397705FX **Nasal Speculum by Killian**, for 118900FX, right blade shortened, 15 cm, blade length left 75 mm
Nasenspekulum nach Killian, für 118900FX, rechtes Blatt gekürzt, 15 cm, Blattlänge links 75 mm



397706FX **Nasal Speculum by Killian**, for 118900FX, left blade shortened, 15 cm, blade length right 75 mm
Nasenspekulum nach Killian, für 118900FX, linkes Blatt gekürzt, 15 cm, Blattlänge rechts 75 mm



041101FX **Nasal Speculum by Hartmann-Halle**, 15.5 cm, blade length 29 mm, size 1
Nasenspekulum nach Hartmann-Halle, 15,5 cm, Blattlänge 29 mm, Fig. 1

041101FX	15.5 cm, blade length 29 mm, size 1	15,5 cm, Blattlänge 29 mm, Fig. 1
041102FX	15.5 cm, blade length 33 mm, size 2	15,5 cm, Blattlänge 33 mm, Fig. 2
041103FX	15.5 cm, blade length 37 mm, size 3	15,5 cm, Blattlänge 37 mm, Fig. 3

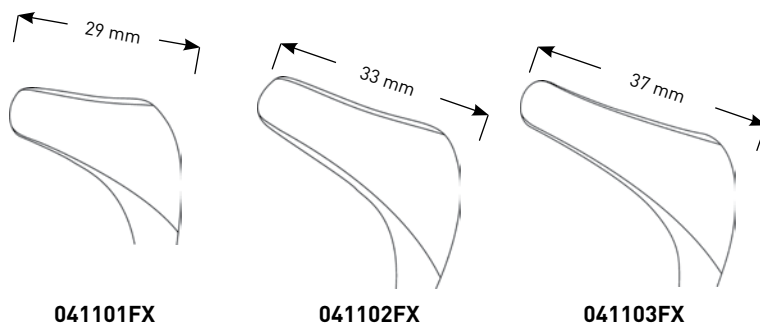



041601FX **Nasal Speculum by Hartmann**, 15 cm, blade length 27 mm, size 1
Nasenspekulum nach Hartmann, 15 cm, Blattlänge 27 mm, Fig. 1

041601FX	15 cm, blade length 27 mm, size 1	15 cm, Blattlänge 27 mm, Fig. 1
041602FX	15 cm, blade length 30 mm, size 2	15 cm, Blattlänge 30 mm, Fig. 2
041603FX	15 cm, blade length 34 mm, size 3	15 cm, Blattlänge 34 mm, Fig. 3

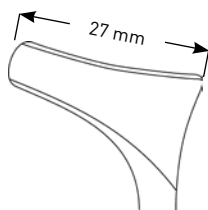

041601FX

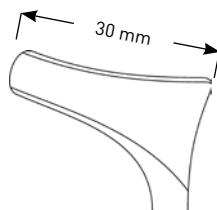

041602FX

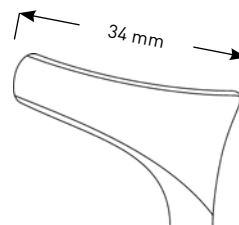

041603FX



041701FX **Nasal Speculum Model Vienna**, 14 cm, blade length 26 mm, size 1
Nasenspekulum Modell Wien, 14 cm, Blattlänge 26 mm, Fig. 1

041701FX	14 cm, blade length 26 mm, size 1	14 cm, Blattlänge 26 mm, Fig. 1
041702FX	14 cm, blade length 29.5 mm, size 2	14 cm, Blattlänge 29,5 mm, Fig. 2
041703FX	14 cm, blade length 33 mm, size 3	14 cm, Blattlänge 33 mm, Fig. 3

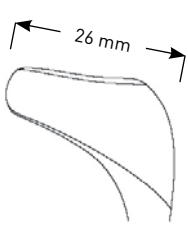

041701FX

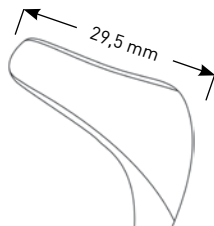

041702FX

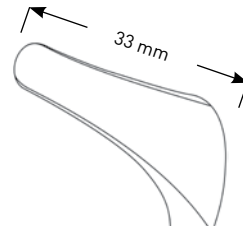

041703FX



043101FX **Nasal Speculum by Hartmann**, for adults, 13 cm, blade length 34 mm
Nasenspekulum nach Hartmann, für Erwachsene, 13 cm, Blattlänge 34 mm

043101FX	for adults / 13 cm, blade length 34 mm	für Erwachsene / 13 cm, Blattlänge 34 mm
043102FX	for children / 13 cm, blade length 27 mm	für Kinder / 13 cm, Blattlänge 27 mm

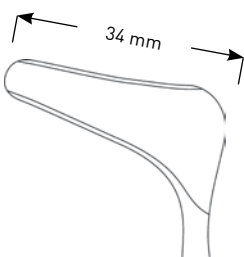

043101FX

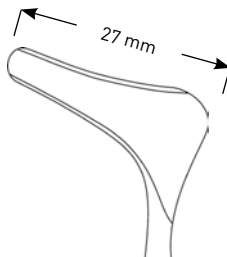

043102FX



042001FX **Nasal Speculum by Killian**, with set screw, 14 cm, blade length 40 mm, size 1
Nasenspekulum nach Killian, mit Stellschraube, 14 cm, Blattlänge 40 mm, Fig. 1

042001FX	with set screw / 14 cm, blade length 40 mm, size 1	mit Stellschraube / 14 cm, Blattlänge 40 mm, Fig. 1
042002FX	with set screw / 14 cm, blade length 55 mm, size 2	mit Stellschraube / 14 cm, Blattlänge 55 mm, Fig. 2
042003FX	with set screw / 14 cm, blade length 75 mm, size 3	mit Stellschraube / 14 cm, Blattlänge 75 mm, Fig. 3
042004FX	with set screw / 14 cm, blade length 90 mm, size 4	mit Stellschraube / 14 cm, Blattlänge 90 mm, Fig. 4

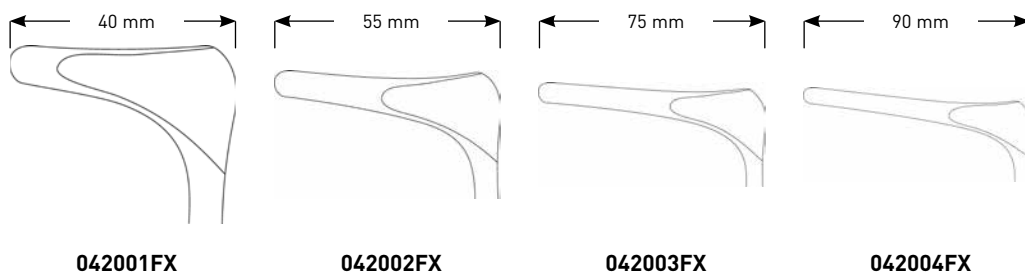



042101FX **Nasal Speculum by Killian**, 14 cm, blade length 40 mm, size 1
Nasenspekulum nach Killian, 14 cm, Blattlänge 40 mm, Fig. 1

042101FX	14 cm, blade length 40 mm, size 1	14 cm, Blattlänge 40 mm, Fig. 1
042102FX	14 cm, blade length 55 mm, size 2	14 cm, Blattlänge 55 mm, Fig. 2
042103FX	14 cm, blade length 75 mm, size 3	14 cm, Blattlänge 75 mm, Fig. 3
042104FX	14 cm, blade length 90 mm, size 4	14 cm, Blattlänge 90 mm, Fig. 4

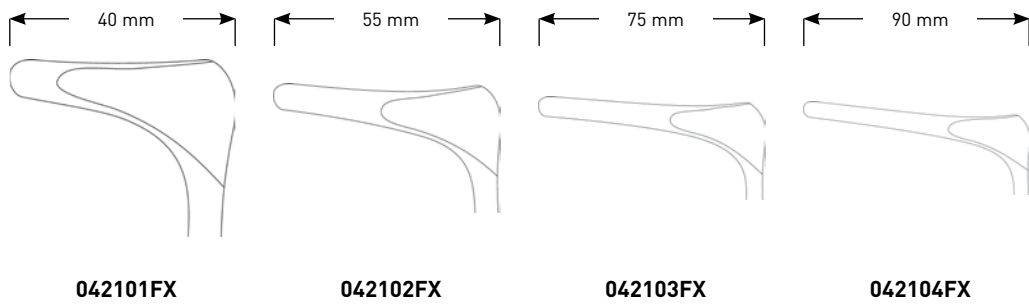



300101FX **Nasal Speculum by Cottle**, with set screw, 13 cm, size 1, blade length 35 mm
Nasenspekulum nach Cottle, mit Stellschraube, 13 cm, Fig. 1, Blattlänge 35 mm

300101FX	with set screw / 13 cm, size 1, blade length 35 mm	mit Stellschraube / 13 cm, Fig. 1, Blattlänge 35 mm
300102FX	with set screw / 13 cm, size 2, blade length 50 mm	mit Stellschraube / 13 cm, Fig. 2, Blattlänge 50 mm
300103FX	with set screw / 13 cm, size 3, blade length 75 mm	mit Stellschraube / 13 cm, Fig. 3, Blattlänge 75 mm
300104FX	with set screw / 13 cm, size 4, blade length 90 mm	mit Stellschraube / 13 cm, Fig. 4, Blattlänge 90 mm

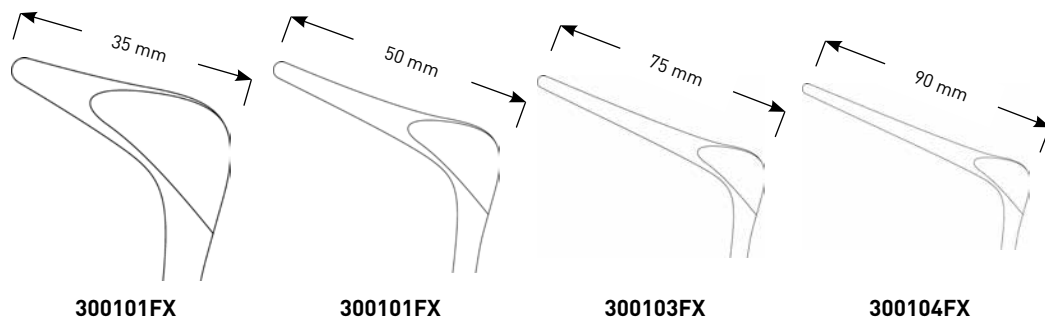



300201FX **Nasal Speculum by Cottle, 13 cm, size 1, blade length 35 mm**
Nasenspekulum nach Cottle, 13 cm, Fig. 1, Blattlänge 35 mm

300201FX	13 cm, size 1, blade length 35 mm	13 cm, Fig. 1, Blattlänge 35 mm
300202FX	13 cm, size 2, blade length 50 mm	13 cm, Fig. 2, Blattlänge 50 mm
300203FX	13 cm, size 3, blade length 75 mm	13 cm, Fig. 3, Blattlänge 75 mm
300204FX	13 cm, size 4, blade length 90 mm	13 cm, Fig. 4, Blattlänge 90 mm

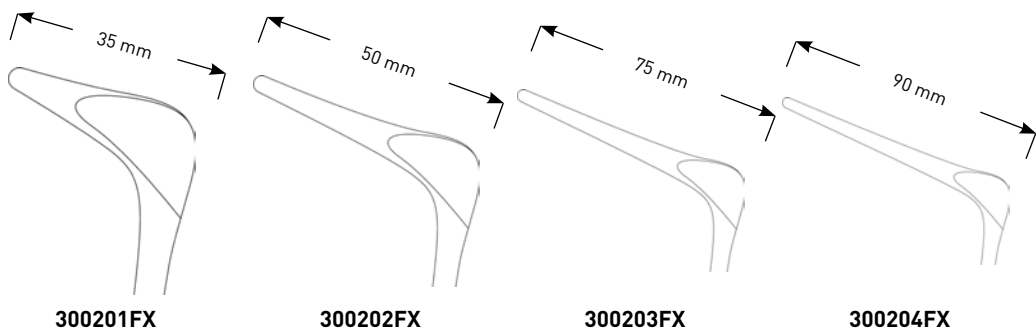

Sinus Surgery
Nasennebenhöhlen



402201FX Retractor by Middeldorpf, 21.5 cm, size 14 x 17 mm
Wundhaken nach Middeldorpf, 21,5 cm, Größe 14 x 17 mm

402201FX	21.5 cm, size 14 x 17 mm	21,5 cm, Größe 14 x 17 mm
402202FX	22 cm, size 20 x 22 mm	22 cm, Größe 20 x 22 mm
402203FX	23.5 cm, size 26 x 30 mm	23,5 cm, Größe 26 x 30 mm



402601FX Retractor by Langenbeck, 21 cm, size 35 x 7 mm
Wundhaken nach Langenbeck, 21 cm, Größe 35 x 7 mm

402601FX	21 cm, size 35 x 7 mm	21 cm, Größe 35 x 7 mm
402602FX	21 cm, size 35 x 10 mm	21 cm, Größe 35 x 10 mm
402603FX	21 cm, size 35 x 15 mm	21 cm, Größe 35 x 15 mm
402604FX	21 cm, size 60 x 20 mm	21 cm, Größe 60 x 20 mm



400112FX **Lip Retractor by Sternberg, 12 cm**
Lippenretraktor nach Sternberg, 12 cm

400112FX	12 cm	12 cm
400114FX	14 cm	14 cm
400116FX	16 cm	16 cm



407200FX **Orbita Protector, 23.5 cm**
Orbitaschützer, 23,5 cm



407312FX **Spatula, malleable, 20 cm, width 12 mm**
Spatel, biegsam, 20 cm, Breite 12 mm

407317FX **Spatula, malleable, 20 cm, width 17 mm**
Spatel, biegsam, 20 cm, Breite 17 mm



086108FX Towel Forceps by Backhaus, 8 cm
Tuchklemme nach Backhaus, 8 cm

086108FX	8 cm	8 cm
086111FX	11 cm	11 cm
086113FX	13 cm	13 cm

Numerical Index
Numerischer Index

Kat. Nr.	Seite
Cat. No.	Page
032416FX	10
041101FX	94
041102FX	94
041103FX	94
041601FX	95
041602FX	95
041603FX	95
041701FX	96
041702FX	96
041703FX	96
042001FX	97
042002FX	97
042003FX	97
042004FX	97
042101FX	98
042102FX	98
042103FX	98
042104FX	98
043101FX	96
043102FX	96
049415FX	9
049418FX	9
049420FX	9
049702FX	10
049703FX	10
049704FX	10
049712FX	10
049713FX	10
049714FX	10
049802FX	11
049803FX	11
049804FX	11
086108FX	103
086111FX	103
086113FX	103
110106FX	11
110107FX	11
110108FX	11
110110FX	11
110112FX	11
110115FX	11
110116FX	12
110118FX	12
110120FX	12
110122FX	12
110125FX	12
111106FX	12
111107FX	12
111108FX	12
111109FX	12
111110FX	12
111112FX	12
111115FX	12
111710FX	13
111810FX	13
118900FX	91
118901FX	92
118903FX	92

Kat. Nr.	Seite
Cat. No.	Page
118904FX	92
136106FX	88
136108FX	88
136110FX	88
136114FX	88
136118FX	88
136123FX	88
136127FX	88
136131FX	88
136135FX	88
136140FX	88
136145FX	88
136150FX	88
136160FX	88
136170FX	88
136206FX	88
136208FX	88
136210FX	88
136214FX	88
136218FX	88
136221FX	88
136223FX	88
136227FX	88
136231FX	88
136235FX	88
136240FX	88
136245FX	88
136250FX	88
136260FX	88
136270FX	88
136414FX	88
136423FX	88
136431FX	88
136440FX	88
136450FX	88
136460FX	88
142106FX	88
142107FX	88
142108FX	88
142110FX	88
142114FX	88
142118FX	88
142121FX	88
142123FX	88
142125FX	88
142127FX	88
142131FX	88
142135FX	88
142140FX	88
142145FX	88
142150FX	88
142160FX	88
142170FX	88
142523FX	88
142527FX	88
142531FX	88
142535FX	88
142540FX	88

Kat. Nr.	Seite
Cat. No.	Page
142545FX	88
142550FX	88
142560FX	88
142570FX	88
153700FX	28
201200FX	18
215100FX	19
215200FX	19
215215FX	19
226100FX	30
226109FX	30
226111FX	30
226200FX	30
226201FX	30
226202FX	30
226300FX	29
226300FXF	29
226301FX	29
226301FXF	29
226302FX	29
226302FXF	29
226303FX	29
226304FX	29
226400FX	30
226401FX	30
226402FX	30
226540FX	84
226541FX	84
226542FX	84
226545FX	84
226570FX	83
226901FX	53
226902FX	53
226903FX	53
226904FX	54
226905FX	55
226906FX	55
226907FX	56
226908FX	56
226909FX	56
226910FX	57
226911FX	57
226912FX	58
226913FX	58
226914FX	59
226915FX	54
227100FX	68
227101FX	68
227102FX	68
227600FX	65
228100FX	79
228101FX	79
228102FX	79
228601FX	66
228602FX	66
228603FX	66
229101FX	80
229102FX	80

Kat. Nr.	Seite
Cat. No.	Page
229103FX	80
229104FX	80
230100FX	60
230101FX	60
230102FX	60
230103FX	60
230104FX	60
230140FX	62
230141FX	62
230142FX	62
230200FX	60
230201FX	60
230202FX	60
230203FX	60
230204FX	60
230240FX	62
230241FX	62
230242FX	62
230300FX	60
230301FX	60
230302FX	60
230303FX	60
230340FX	62
230341FX	62
230342FX	62
230500FX	78
230600FX	63
230700FX	63
231601FX	61
231602FX	61
231603FX	61
231701FX	61
231702FX	61
231801FX	61
231802FX	61
234210FX	79
234220FX	79
234300FX	66
234345FX	66
234400FX	67
234445FX	67
234500FX	67
234545FX	67
234603FX	35
234606FX	35
234613FX	41
234616FX	41
234623FX	41
234626FX	41
234835FX	37
234845FX	37
234865FX	37
234866FX	37
234901FXF	77
234902FXF	77
234903FX	77
234904FX	77
235035FX	40

Numerical Index

Numerischer Index

Kat. Nr. Cat. No.	Seite Page	Kat. Nr. Cat. No.	Seite Page	Kat. Nr. Cat. No.	Seite Page	Kat. Nr. Cat. No.	Seite Page
235035FXF	40	235902FX	64	239302FX	85	260331FX	89
235036FXF	38	236000FX	65	239401FX	85	260335FX	89
235045FX	40	236001FX	65	239402FX	85	260406FX	89
235045FXF	40	236002FX	65	239501FX	85	260410FX	89
235046FXF	38	236301FX	43	239502FX	85	260418FX	89
235065FX	40	236301FXF	43	241100FX	81	260421FX	89
235065FXF	40	236302FX	43	241145FX	81	260423FX	89
235066FXF	39	236302FXF	43	241190FX	81	260425FX	89
235075FX	40	236303FX	43	242100FX	81	260427FX	89
235075FXF	40	236303FXF	43	250106FX	13	260431FX	89
235076FXF	39	236304FX	43	250108FX	13	260435FX	89
235100FX	72	236304FXF	43	250110FX	13	260440FX	89
235101FX	72	236311FX	42	250112FX	13	260445FX	89
235102FX	72	236312FX	42	250115FX	13	260460FX	89
235110FX	74	236313FX	42	250220FX	14	260470FX	89
235111FX	74	236314FX	42	250221FX	14	260823FX	89
235115FX	74	236333FX	42	250318FX	88	260831FX	89
235120FX	73	236334FX	42	250323FX	88	260840FX	89
235121FX	73	236343FX	42	250327FX	88	260850FX	89
235122FX	73	236344FX	42	250331FX	88	260860FX	89
235125FX	75	236500FX	49	250335FX	88	260870FX	89
235150FX	75	236501FX	49	250340FX	88	300101FX	99
235200FX	76	236502FX	49	250345FX	89	300102FX	99
235201FX	76	236600FX	50	250350FX	89	300103FX	99
235202FX	76	236601FX	50	250360FX	89	300104FX	99
235210FX	46	236602FX	50	250370FX	89	300201FX	100
235211FX	46	236702FX	52	250406FX	88	300202FX	100
235214FX	46	236703FX	52	250410FX	88	300203FX	100
235224FX	46	236704FX	52	250423FX	88	300204FX	100
235270FX	46	236712FX	52	250427FX	88	305100FX	19
235270FXF	46	236900FX	63	250435FX	88	305900FX	19
235271FX	46	236901FX	63	250440FX	88	360100FX	20
235271FXF	46	236902FX	63	250445FX	89	397701FX	93
235300FX	51	237000FX	64	250450FX	89	397702FX	93
235301FX	51	237001FX	64	250470FX	89	397705FX	93
235501FX	44	237002FX	64	250723FX	88	397706FX	94
235501FXF	44	238101FX	69	250727FX	88	400112FX	102
235502FX	44	238102FX	69	250731FX	88	400114FX	102
235502FXF	44	238201FX	69	250740FX	88	400116FX	102
235503FX	44	238202FX	69	250806FX	88	402201FX	101
235504FX	44	238513FX	82	250808FX	88	402202FX	101
235505FX	45	238516FX	82	250810FX	88	402203FX	101
235505FXF	45	238519FX	82	250818FX	88	402601FX	101
235506FX	45	238613FX	82	250823FX	88	402602FX	101
235506FXF	45	238616FX	82	250831FX	88	402603FX	101
235507FX	45	238619FX	82	250835FX	88	402604FX	101
235508FX	45	238713FX	83	250840FX	88	403101FX	27
235508FXF	45	238716FX	83	250845FX	89	403102FX	27
235509FX	45	238719FX	83	250850FX	89	403103FX	27
235509FXF	45	238813FX	84	250860FX	89	403104FX	27
235510FX	45	238816FX	84	250870FX	89	403105FX	28
235510FXF	45	239003FX	87	250931FX	88	403106FX	28
235513FX	44	239101FX	85	250940FX	88	404100FX	26
235513FXF	44	239102FX	85	250950FX	89	406101FX	26
235514FX	44	239103FX	85	250960FX	89	406102FX	26
235514FXF	44	239104FX	85	260318FX	89	406103FX	26
235900FX	64	239201FX	87	260323FX	89	407125FX	21
235901FX	64	239301FX	85	260327FX	89	407130FX	21

Numerical Index
Numerischer Index

Kat. Nr.	Seite
Cat. No.	Page
407140FX	21
407150FX	21
407200FX	102
407312FX	102
407317FX	102
408600FX	22
411100FX	23
411200FX	23
412101FX	33
412102FX	33
412301FX	33
412302FX	33
412401FX	33
412402FX	33
412502FX	31
412503FX	31
412600FX	34
412601FX	34
412702FX	36
412703FX	36
413001FX	32
413002FX	32
413003FX	32
413004FX	32
413021FX	32
413022FX	32
413023FX	32
413024FX	32
413100FX	34
413200FX	35
413402FX	32
413403FX	32
413404FX	32
415100FX	47
415105FX	47
415170FX	48
415210FX	48
415600FX	70
415600FXF	70
415601FX	70
415602FX	70
415603FX	70
415604FX	70
415604FXF	70
415605FX	70
415605FXF	70
415610FX	71
415630FX	71
418100FX	23
418101FX	24
418102FX	24
418103FX	24
418201FX	24
418202FX	24
418203FX	24
418204FX	25
418205FX	25
418210FX	22

Kat. Nr.	Seite
Cat. No.	Page
418211FX	22
418303FX	26
418304FX	26
418350FX	86
418351FX	86
418352FX	86
418353FX	86
418401FX	28
418402FX	28
418403FX	28
418404FX	28
418500FX	9
418600FX	9
418603FX	9
418604FX	9
418719FX	20
418825FX	20
418826FX	21
419000FX	86
726504FX	17
726506FX	17
726508FX	17
726516FX	17
728100FX	6
728130FX	6
728170FX	6
728200FX	6
728230FX	6
728270FX	6
728500FX	6
728530FX	6
728570FX	6
730100FX	7
730116FX	15
730119FX	15
730130FX	7
730145FX	7
731116FX	15
731119FX	15
732116FX	15
732119FX	15
741116FX	15
741119FX	15
741200FX	8
742116FX	15
742119FX	15
750100FX	7
750130FX	7
750145FX	7
750170FX	7
750861FX	16
761116FX	16
761119FX	16
762119FX	16
829700FX	90
829720FX	90
829750FX	90
829800FX	90

Kat. Nr.	Seite
Cat. No.	Page
829855FX	90
829880FX	90
863100FX	8
863101FX	8
863110FX	8

Kat. Nr.	Seite
Cat. No.	Page

Numerical Index
Numerischer Index

Kat. Nr.	Seite
Cat. No.	Page

Kat. Nr.	Seite
Cat. No.	Page

Kat. Nr.	Seite
Cat. No.	Page

Kat. Nr.	Seite
Cat. No.	Page

Author / Description	Page
Adapter	92
Antifog solution "ULTRA STOP"	8
Antrum Cannula by Van Eicken	10, 11
Antrum Curette	24, 26
Antrum Curette by Coakley	27, 28
Antrum Curette by Faulkner	26
Antrum Elevator by Sewall	23
Antrum Grasping Forceps	70, 71
Antrum Punch	74, 75
Antrum Punch by Beyer	34
Antrum Punch by Ostrum	72, 73, 74
Antrum Punch by Tobey	75
Antrum Rasp by Watson-Williams	22
Antrum Side-Biting Punch	77
Antrum Suction Punch	76
Antrum Trocar Needle by Lichtwitz	9
Biopsy and Grasping Forceps	47
Bipolar Cable	17
Bipolar Forceps	15, 16
Bone Punch	31
Burr	88, 89
Chisel by West	23
Circular Cutting Punch	35, 37, 40, 41
Circular Cutting Punch (Gear Type)	38, 39
Clamp	92
Dissector	87
Double Spoon Forceps	44, 45, 46
Ear Dressing Forceps by Jansen	10
Elevator by Freer	19
Ethmoid Forceps by Draf	82, 83
Ethmoid Scissors by Draf	84
Flexible Arm with Holding Rod	91
Forceps by Struempel	81
Frontal Sinus Bougie by Ritter-Halle	21
Frontal Sinus Curette	25
Frontal Sinus Punch	36, 42, 43
Frontal Sinus Rasp by Wigand	22
Frontal Sinus Seeker by Castelnuovo	20
Frontal Sinus Seeker by Kuhn	21
Gouge by West	23
Handpiece	90
Hi-View Telescope	6, 7
Hook	86
Lip Retractor by Sternberg	102
Maxillary Biopsy Forceps	48
Maxillary Sinus Seeker	20
Micro Elevator by Draf	85
Nasal Cutting Forceps by Gruenwald-Henke	66
Nasal Cutting Forceps by Hartmann	80
Nasal Cutting Forceps by Schmeden	79
Nasal Cutting Forceps by Struycken	65
Nasal Cutting Forceps by Wigand	67
Nasal Forceps	53, 54, 56, 57, 58, 59
Nasal Forceps by Blakesley	60, 61, 62, 63, 64, 65
Nasal Forceps by Blakesley-Wilde	60
Nasal Forceps by Takahashi	68
Nasal Forceps by Wigand	66
Nasal Scissors	29, 30, 84

Author / Description	Page
Nasal Scissors by Heymann	30
Nasal Speculum Model Vienna	96
Nasal Speculum by Cottle	99, 100
Nasal Speculum by Hartmann	95, 96
Nasal Speculum by Hartmann-Halle	94
Nasal Speculum by Killian	93, 94, 97, 98
Nasal Spoon Forceps	54, 55, 56, 83
Orbita Protector	102
Polyp Forceps by Watson-Williams	79
Polyp Grasping Forceps by Wigand	78
Protection Tube	8
Retractor by Langenbeck	101
Ring Curette by Cappabianca-de Divitiis	86
Round Knife by Draf	85
S-Bite Nasal Forceps	49, 50, 52
Scissors by Bellucci	81
Septum Needle	18
Sickle Knife	28
Sickle Knife by Draf	87
Sickle Knife by Plester	28
Sinuscopy Trocar	9
Spatula	102
Sphenoid Punch by FS-Kerrison	32
Sphenoid Punch by Hajek-Kofler	33, 34
Sphenoid Punch by McKenty	35
Suction Elevator by Gorney	19
Suction Elevator by Guillen	20
Suction Forceps by Blakesley	63, 64
Suction Forceps by Gruenwald	51
Suction Forceps by Takahashi	69
Suction Tube by Frank-Pasquini	14
Suction Tube by Frazier	11, 12, 13
Telescope Clamp	92
Towel Forceps by Backhaus	103

Author / Description	Page
----------------------	------

Author / Description	Page
----------------------	------

Autor / Beschreibung	Seite
Adapter	92
Antibesclagmittel „ULTRA STOP“	8
Antrum Seitwärtsstanze	77
Antrum-Kürette.	26
Antrum-Saugstanze	76
Antrumlöffel.	24
Antrumstanze.	74, 75
Antrumstanze nach Ostrum	72, 73, 74
Antrumstanze nach Tobey	75
Bipolare Pinzette	15, 16
Bipolares HF Kabel.	17
Bohrer	88, 89
Bohrhandstück	90
Conchotom nach Grünwald-Henke	66
Conchotom nach Hartmann	80
Conchotom nach Schmeden	79
Conchotom nach Struycken	65
Conchotom nach Wigand.	67
Dissektor	87
Doppelevatorium nach Freer	19
Doppellöffel-Zange	44, 45, 46
Flachmeißel nach West	23
Flexibler Arm mit Haltestange	91
Hi-View Optik	6, 7
Hohlmeißel nach West	23
Häkchen	86
Keilbeinstanze nach McKenty	35
Kieferhöhlen Probeexzisionszange	48
Kieferhöhlen-Elevatorium nach Sewall.	23
Kieferhöhlenfasszange.	70, 71
Kieferhöhlenkürette nach Coakley	27, 28
Kieferhöhlenkürette nach Faulkner.	26
Kieferhöhlenpunktionsnadel n. Lichtwitz.	9
Kieferhöhlenraspel nach Watson-Williams.	22
Kieferhöhlensonde	20
Kieferhöhlenstanze nach Beyer	34
Knochenstanze	31
Knochenstanze nach FS-Kerrison.	32
Knochenstanze nach Hajek-Kofler	33, 34
Lippenretraktor nach Sternberg	102
Mikro-Elevatorium nach Draf	85
Nasenlöffelzange	54, 55, 56, 83
Nasenschere	29, 30, 84
Nasenschere nach Heymann	30
Nasenspekulum Modell Wien	96
Nasenspekulum nach Cottle.	99, 100
Nasenspekulum nach Hartmann	95, 96
Nasenspekulum nach Hartmann-Halle.	94
Nasenspekulum nach Killian	93, 94, 97, 98
Nasenzange.	53, 54, 56, 57, 58, 59
Nasenzange nach Blakesley.	60, 61, 62, 63, 64, 65
Nasenzange nach Blakesley-Wilde	60
Nasenzange nach Takahashi.	68
Nasenzange nach Wigand	66
Ohrpinzette nach Jansen.	10
Optik-Klammer	92
Orbitaschützer	102
Polypenfasszange nach Wigand	78

Autor / Beschreibung	Seite
Polypenzange nach Watson-Williams.	79
Probeexzisions- und Fasszange.	47
Ringkürette nach Cappabianca-de Divitiis	86
Rundkopfstanze.	35, 37, 40, 41
Rundkopfstanze (Zahnradmechanik)	38, 39
Rundschnittmesser nach Draf.	85
S-Bite Nasenzange	49, 50, 52
Saugelevatorium nach Gorney.	19
Saugelevatorium nach Guillen.	20
Saugkanüle nach Frazier.	13
Saugrohr nach Frank-Pasquini	14
Saugrohr nach Frazier	11, 12
Saugrohr nach Kahn-Frazier	13
Saugzange nach Blakesley.	63, 64
Saugzange nach Grünwald.	51
Saugzange nach Takahashi	69
Schere nach Bellucci.	81
Schutzhülse	8
Septumkanüle	18
Sichelmesser	28
Sichelmesser nach Draf	87
Sichelmesser nach Plester	28
Siebbeinschere nach Draf	84
Siebbeinzange nach Draf.	82, 83
Sinuskopie-Trokar	9
Spannkloben	92
Spatel	102
Spülröhrchen nach Van Eicken	10, 11
Stirnhöhlen-Stanze.	42, 43
Stirnhöhlenbougie nach Ritter-Halle	21
Stirnhöhlenlöffel	25
Stirnhöhlenraspel nach Wigand	22
Stirnhöhlensonde nach Castelnuovo	20
Stirnhöhlensonde nach Kuhn	21
Stirnhöhlenstanze	36
Tuchklemme nach Backhaus	103
Wundhaken nach Langenbeck.	101
Zängchen nach Strümpel	81

Autor / Beschreibung	Seite
----------------------	-------

Autor / Beschreibung	Seite
----------------------	-------

FENTEX*medical* GmbH

take-off GewerbePark 2
D-78579 Neuhausen ob Eck

Tel. +49 (0) 7467 - 949 62 0
Fax +49 (0) 7467 - 949 62 17
info@fentexmedical.com
www.fentexmedical.com

FENTEX *Instruments · Made in Germany*

© FENTEXmedical GmbH · 2024 · Art.-Nr 003FX

